

PRODUCT CATALOGUE

Ürün Katalođu

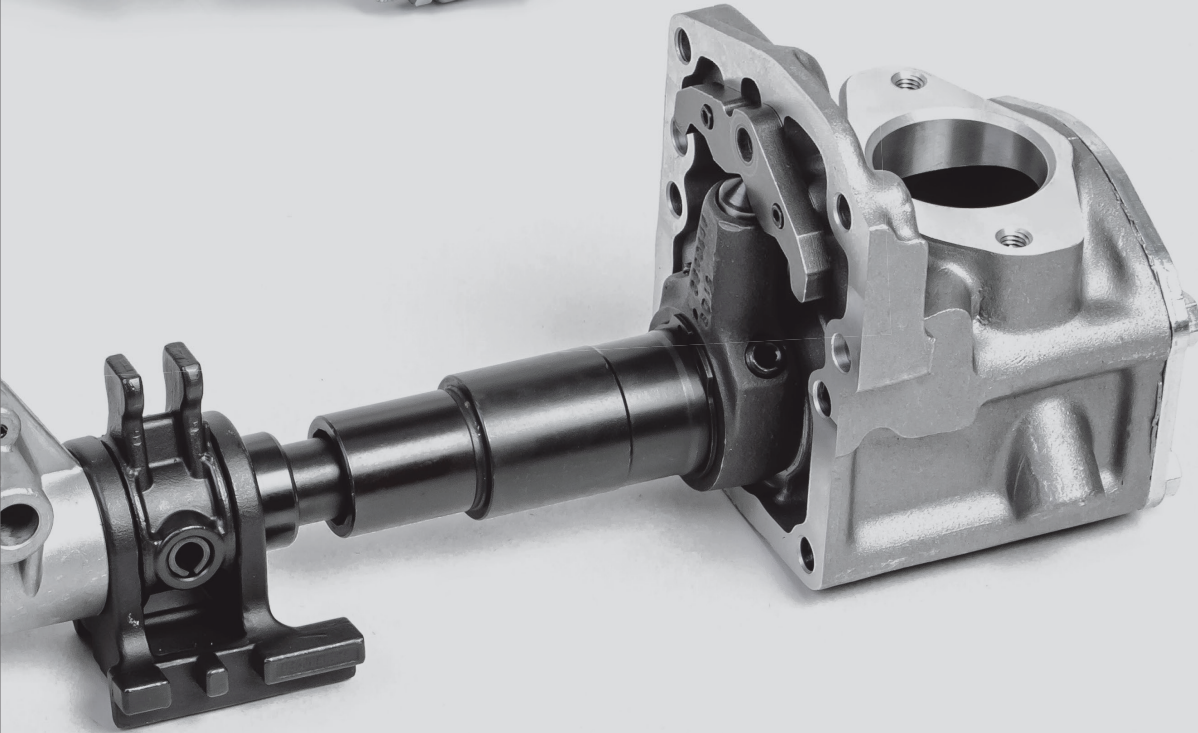

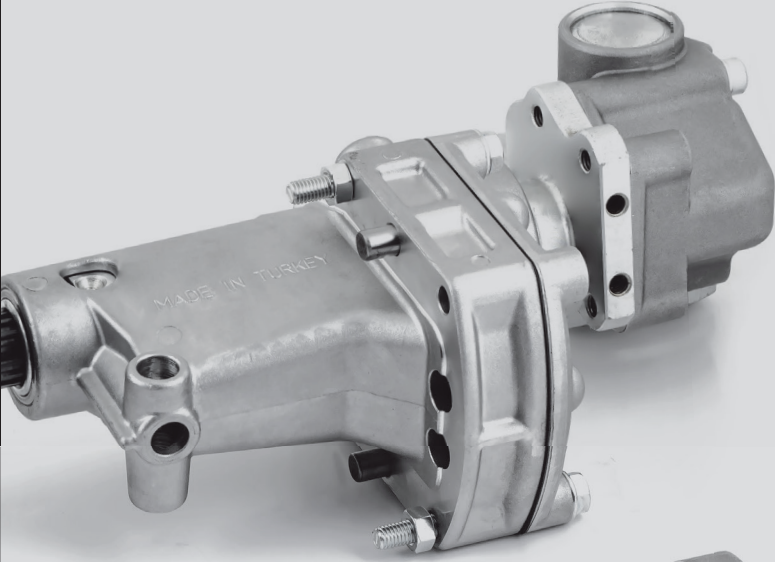

INDEX

| | |
|------------|---|
| 02 | ● About Us |
| 10 | ● Gear Lever Assy |
| 24 | ● Conversion Kits |
| 28 | ● Gear Linkage System |
| 38 | ● G240 Conversion Kit Spare Parts |
| 46 | ● CEKA Conversion Kit Spare Parts |
| 54 | ● G155 16 Gear Conversion Kit Spare Parts |
| 62 | ● G155 9 Gear Conversion Kit Spare Parts |
| 70 | ● MERCEDES-BENZ Transmission Spare Parts |
| 94 | ● ZF Transmission Spare Parts |
| 115 | ● VOLVO Transmission Spare Parts |
| 116 | ● SCANIA Transmission Spare Parts |
| 117 | ● CABIN Spare Parts |
| 118 | ● Puller Kits |
| 142 | ● Product List |



İÇİNDEKİLER

| | |
|------------|--|
| 02 | ● Hakkımızda |
| 10 | ● Vites Kolu Takımları |
| 24 | ● Kule Takımları |
| 28 | ● Vites Kolu Bağlantıları |
| 38 | ● G240 Kule Yedek Parçaları |
| 46 | ● CEKA Kule Yedek Parçaları |
| 54 | ● G155 16 Vites Kule Yedek Parçaları |
| 62 | ● G155 9 Vites Kule Yedek Parçaları |
| 70 | ● MERCEDES-BENZ Şanzıman Yedek Parçaları |
| 94 | ● ZF Şanzıman Yedek Parçaları |
| 115 | ● VOLVO Şanzıman Yedek Parçaları |
| 116 | ● SCANIA Şanzıman Yedek Parçaları |
| 117 | ● KABİN Yedek Parçaları |
| 118 | ● Çektirmeler |
| 142 | ● Ürün Listesi |



ABOUT US

CONTINUOUSLY INCREASING PRODUCT NUMBER and PRODUCT QUALITY SINCE 2005

CE-KA Automotive has been manufacturing automotive spare parts and molds since 2005.

Our company manufactures transmission parts of all kinds of heavy vehicles, as well as all spare parts of Man, Mercedes, Iveco, Renault, Daf, Volvo, Scania and Zf transmissions.

The product range of our company is growing with each passing day.

Our productions are produced flawlessly with our experienced personnel on high technology, state-of-the-art CNC machines.

All product manufacturing stages, including packaging, are carried out in our own company.

As CEKA , we export our products to all over the world.



PRODUCT DELIVER FROM STOCK



We keep almost all of our products in our stocks in order to provide fast product supply to our customers.

HIGH PRODUCT QUALITY



Necessary quality control processes are carried out for each product produced, and the number of defective products is close to zero.

CUSTOMER ORIENTED PRODUCTION



We also supply intermediate products to meet the needs of our customers.



HAKKIMIZDA

2005 YILINDAN GÜNÜMÜZE SÜREKLİ ARTAN ÜRÜN SAYISI ve ÜRÜN KALİTESİ

Firmamız CE-KA Otomotiv 2005 yılından beri otomotiv yedek parça ve kalıp imalatı yapmaktadır.

Firmamız her tür ağır vasıta araçlarının şanzıman parçaları ve aynı zamanda Man, Mercedes, Iveco, Renault, Daf, Volvo, Scania ve Zf şanzımanlarının tüm yedek parçalarının imalatını yapmaktadır.

Firmamızın ürün yelpazesi her geçen büyümektedir.

İmalatlarımız yüksek teknolojiye sahip, son model CNC tezgahlarda alanında tecrübeli personellerimiz eşliğinde hatasız bir şekilde üretilmektedir.

Ürün imalat aşamalarının hepsi, paketlenmesi de dahil olmak üzere kendi firmamız bünyesinde yapılmaktadır.

Ceylan Kalıp olarak imal ettiğimiz ürünlerimizi Dünya'nın her yerine ihraç etmekteyiz.



STOKTAN ÜRÜN TESLİMİ



Ürünlerimizin neredeyse tamamını müşterilerimize hızlı ürün temini sağlayabilmek için sürekli stoklarımızda tutmaktayız.

YÜKSEK ÜRÜN KALİTESİ



Üretilen her bir ürün için gereken kalite kontrol işlemleri yapılmakta olup, hatalı ürün sayısı sıfıra yakındır.

MÜŞTERİ ODAKLI ÜRETİM



Müşterilerimizin ihtiyaçlarını karşılayabilmek için ara ürün tedaklininde gerçekleştirmekteyiz.



VISION

As CE-KA Automotive, we aim to keep consumer satisfaction above all else and to protect the consumer satisfaction we have earned. We aim to be a leader in the industry and the first company that comes to mind, advanced in terms of technology, attaches importance to consumer needs, and takes care of consumer needs.

Our Vision;

As CE-KA Automotive, we aim to keep consumer satisfaction above all else and to protect the consumer satisfaction we have earned. We aim to meet the needs and expectations of our consumers by acquiring production technologies and experienced staff that can meet the needs of our national and international consumers. We aim to be a company that is known in the sector and stands out with its quality and customer satisfaction. We aim to catch the international standard existing in the sector and raise the bar of national standards.



VİZYON

CE-KA Otomotiv olarak tüketici memnuniyetini herşeyden önce tutmayı ve kazandığımız tüketici memnuniyetini korumayı hedefliyoruz. Sektöründe lider ve ilk akla gelen, teknoloji bakımından gelişmiş, tüketici ihtiyaçlarına önem veren, tüketici ihtiyaçlarını gözeten bir firma olmayı amaçlıyoruz.

Vizyonumuz;

CE-KA Otomotiv olarak tüketici memnuniyetini herşeyden önce tutmayı ve kazandığımız tüketici memnuniyetini korumayı hedefliyoruz. Ulusal ve uluslararası tüketicilerimizin ihtiyaçlarını karşılayabilecek üretim teknolojileri ve alanında deneyimli elemanlar edinerek, tüketicilerimizin ihtiyaç ve beklentilerini karşılamayı amaç ediniyoruz. Sektörün tanınan, kalitesi ve sağladığı müşteri memnuniyeti ile öne çıkan bir firma olmayı hedefliyoruz. Sektörde mevcut olan uluslararası standartı yakalayıp, ulusal standartların çitasını yükseltmeyi hedefliyoruz.





MISSION

Our Mision;

We aim to be a leader in the industry and the first company that comes to mind, advanced in terms of technology, attaches importance to consumer needs, and takes care of consumer needs. We aim to increase our export rate, which is the current situation, and to become an international company by rapidly expanding our product range. We aim not only to follow the constantly developing technology in the sector, but to continuously integrate them into our company, to make more professional and mass productions, thus to accelerate our time in meeting customer needs, and to offer faultless and better quality products.

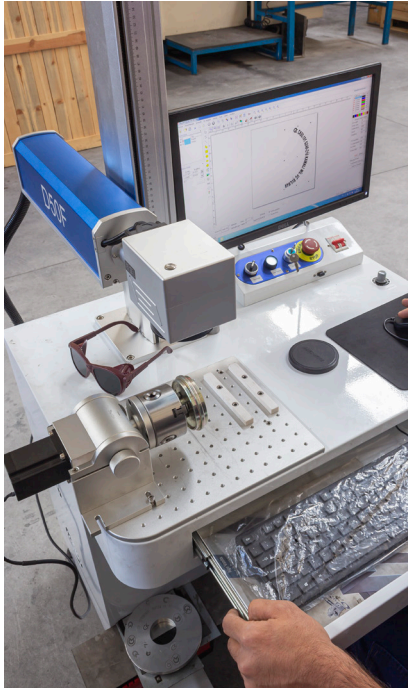

MİSYON

Misyonumuz;

Sektöründe lider ve ilk akla gelen, teknoloji bakımından gelişmiş, tüketici ihtiyaçlarına önem veren, tüketici ihtiyaçlarını gözeterek bir firma olmayı amaçlıyoruz. Ürün yelpazemizi hızla genişleterek mevcut durumu olan ihraç oranımızı sürekli artırmayı ve uluslararası bir firma olmayı hedefliyoruz. Sektörde devamlı gelişen teknolojiyi takip etmekle kalmayıp, sürekli olarak bunları firmamız bünyesine entegre ederek daha profesyonel ve seri üretimler yapmayı bu sayede müşteri ihtiyaçlarını karşılamadaki süremizi hızlandırmayı, hatasız ve daha kaliteli ürünler sunmayı amaç edinmiş durumdayız.





QUALITY POLICY

- Analyzing and meeting the needs of all our customers,
- To include the technology and experienced personnel required to meet these needs in the best and fastest way,
- Continuous training and development of our staff,
- To work with professional staff who love their job,
- To improve our product range continuously,
- Increasing our export rates,
- To maintain customer satisfaction before and after sales,
- To protect all these quality policies





KALİTE POLİTİKAMIZ

- Tüm müşterilerimizin ihtiyaçlarını analiz etmek ve karşılamak,
- Bu ihtiyaçları en iyi ve en hızlı şekilde karşılamak için gerekli olan teknoloji ve tecrübeli personelleri bünyemize dahil etmek,
- Personellerimizi devamlı eğitip, geliştirmek,
- İşini seyerek yapan profesyonel personellerle çalışmak,
- Ürün yelpazemizi sürekli geliştirmek,
- İhracat oranlarımızı artırmak,
- Satış öncesi ve satış sonrası müşteri memnuniyetini korumak,
- Tüm bu kalite politikalarımızı korumak



Gear Lever Assy

Vites Kolu Takımları



GEAR LEVER ASSY

VİTES KOLU TAKIMLARI

CK18.0250

Gear Lever Assy-CEKA Electric Model V6
with 2 Valves

CEKA Model Elektrikli V6 Set Boru Ve
Zadet Ventil Dahil

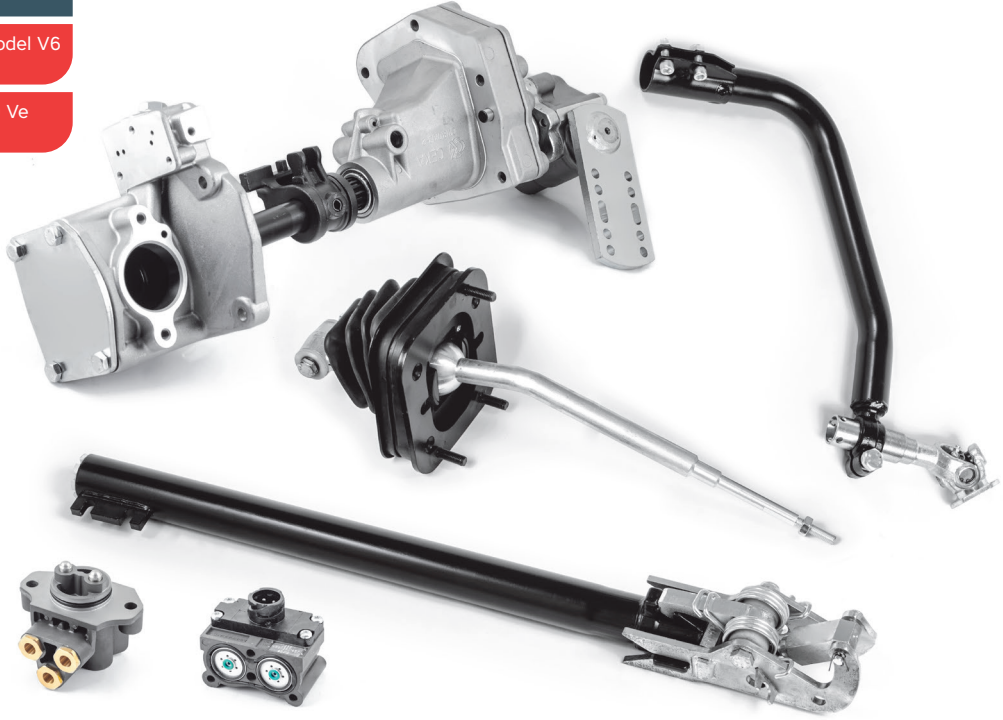

INCLUDE
VALVES

CK18.0254

Gear Lever Assy-CEKA Electric Model V6
without Valves

CEKA Model Elektrikli V6 Set Boru

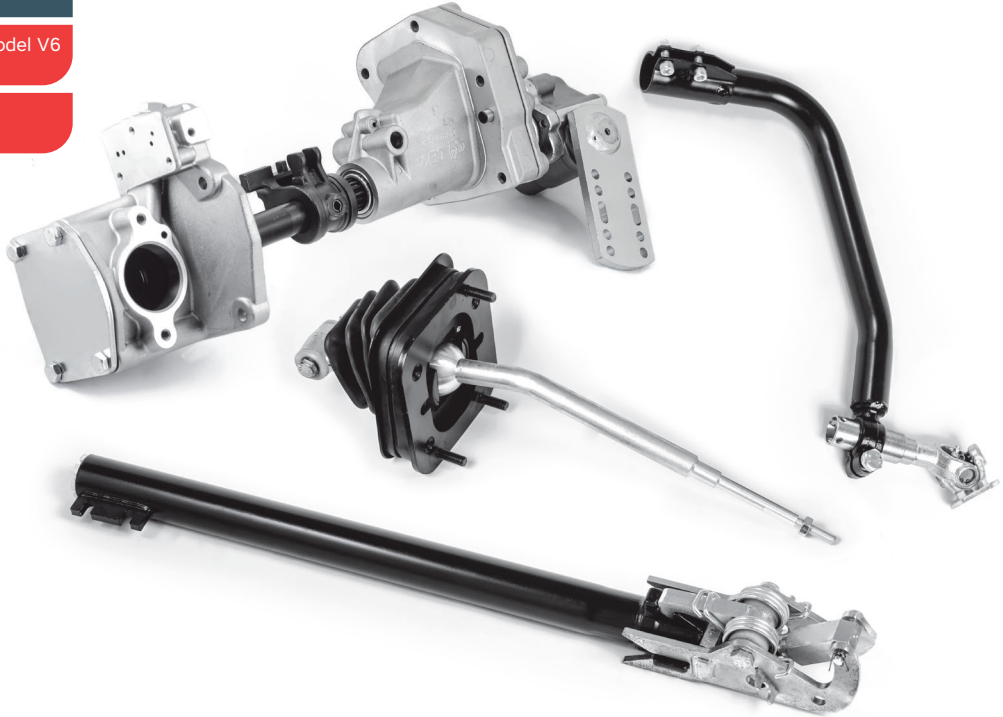

Gear Lever Assy

Vites Kolu Takımları

CK18.0251

Gear Lever Assy-CEKA Mechanic Model
V6 with 2 Valves

CEKA Model Kibritli V6 Set Boru
ve 2adet Ventil Dahil

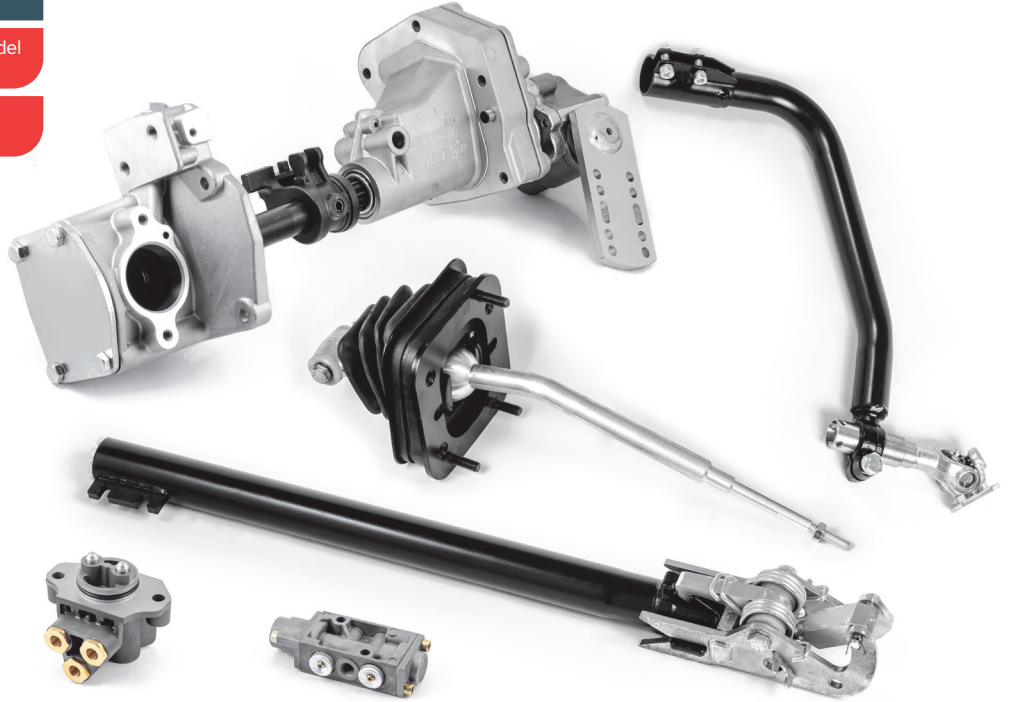

INCLUDE
VALVES

CK18.0255

Gear Lever Assy-CEKA Mechanic Model
V6 without Valves

CEKA Model Kibritli V6 Set Boru



CK18.0240

Gear Lever Assy V6 with 2 Valves

Ventiler Ve Boru Dahil Set V6

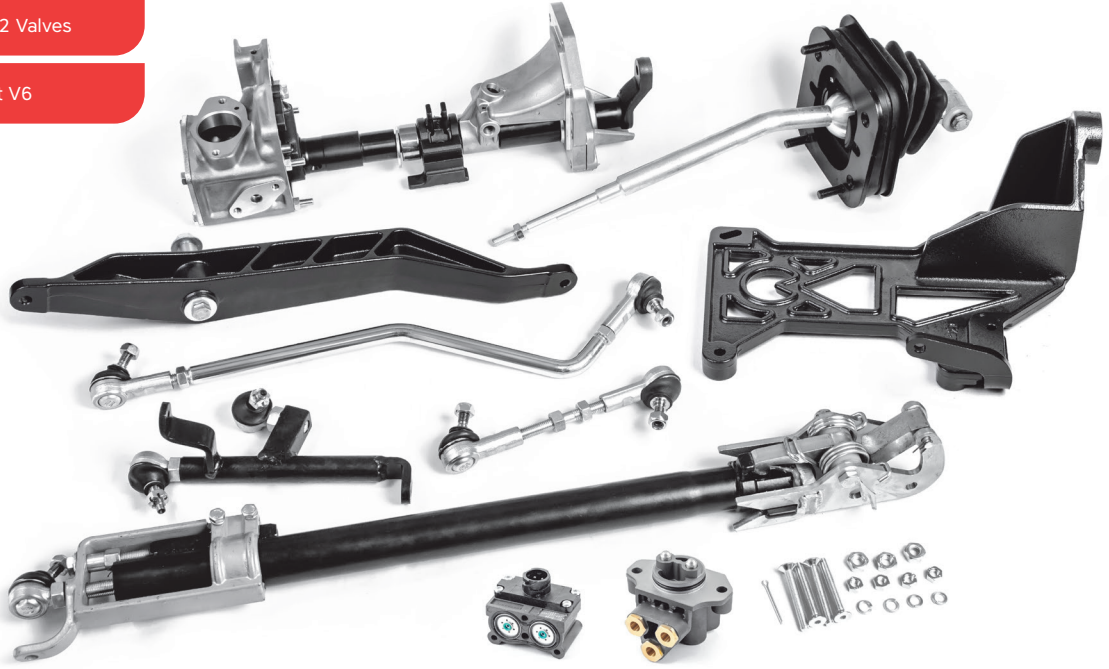

INCLUDE
VALVES

CK18.0241

Gear Lever Assy V6

Kule Boru Set V6

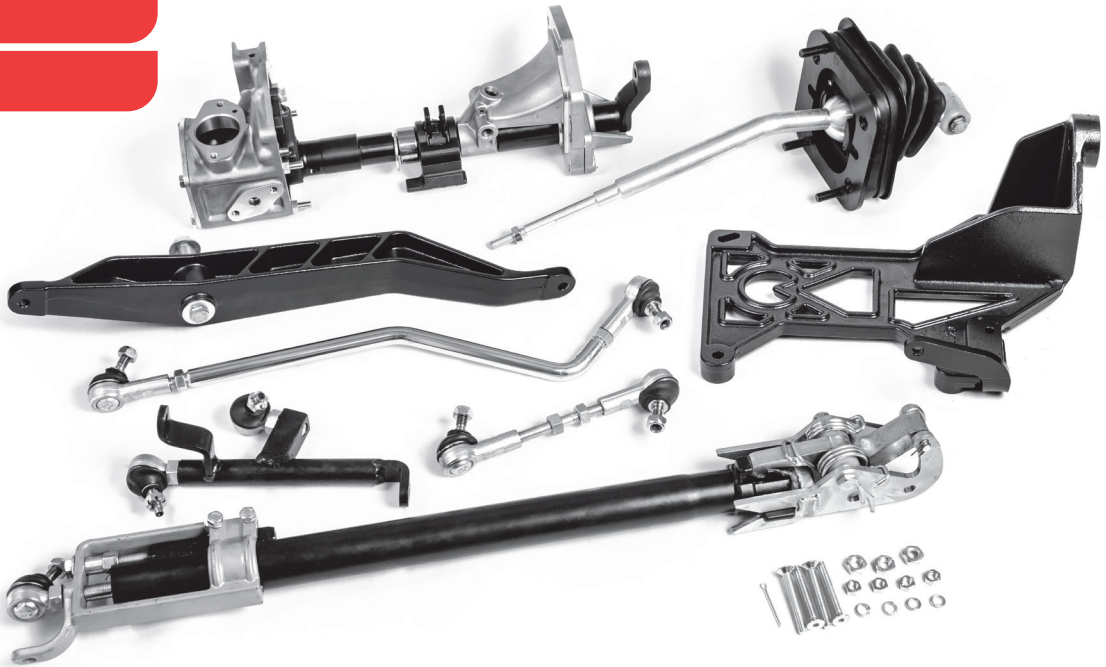

Gear Lever Assy

Vites Kolu Takımları

CK18.0244

Gear Lever Assy V8 with 2 Valves

Ventiler Ve Boru Dahil Set V8

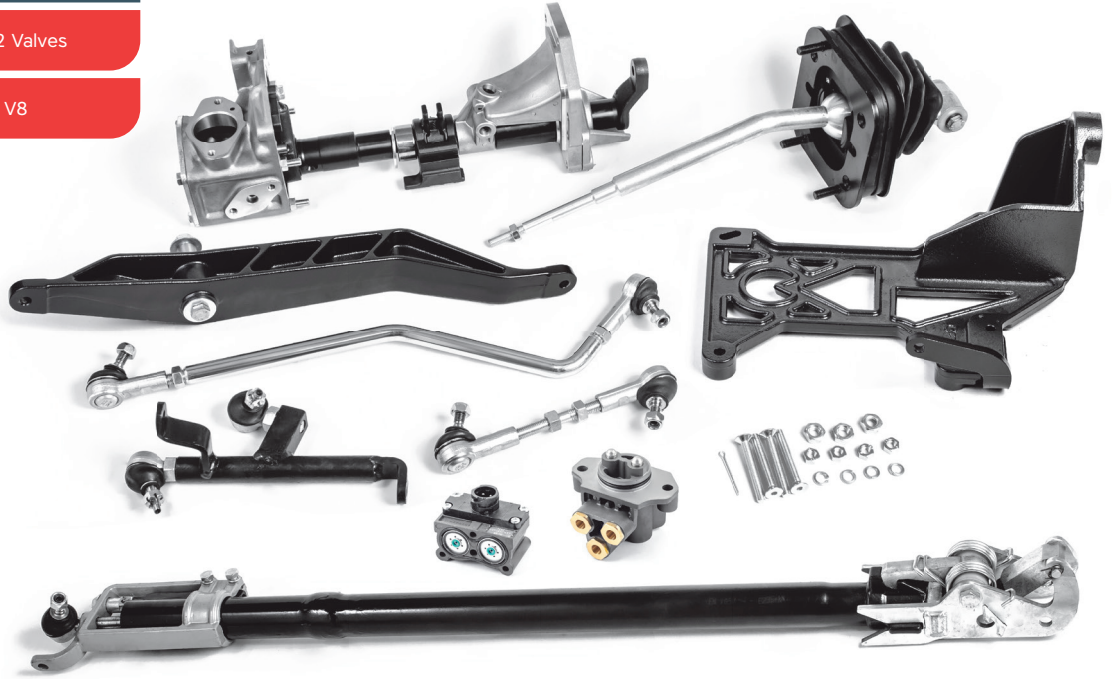
**INCLUDE
VALVES**

CK18.0245

Gear Lever Assy V8

Kule Boru Set V8

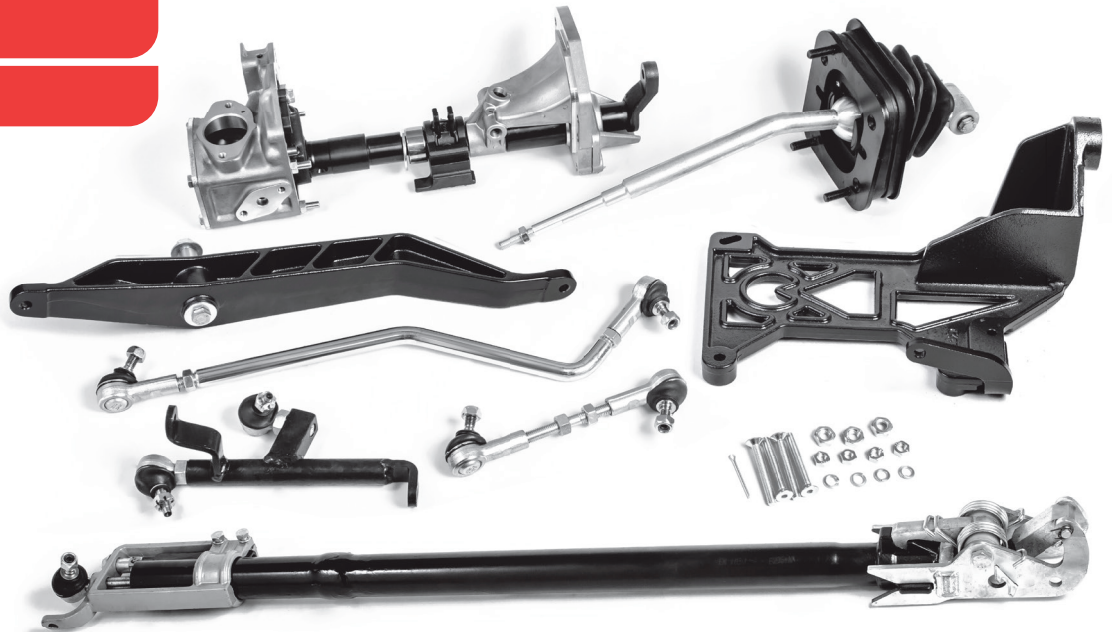

CK 18.0248

Gear Lever Assy Concrete Mixer With Valves

Beton Mikseri Vites Sistemi ve 2 Adet Ventil Dahil



INCLUDE
VALVES

CK 18.0249

Gear Lever Assy Concrete Mixer Without Valves

Beton Mikseri Vites Sistemi

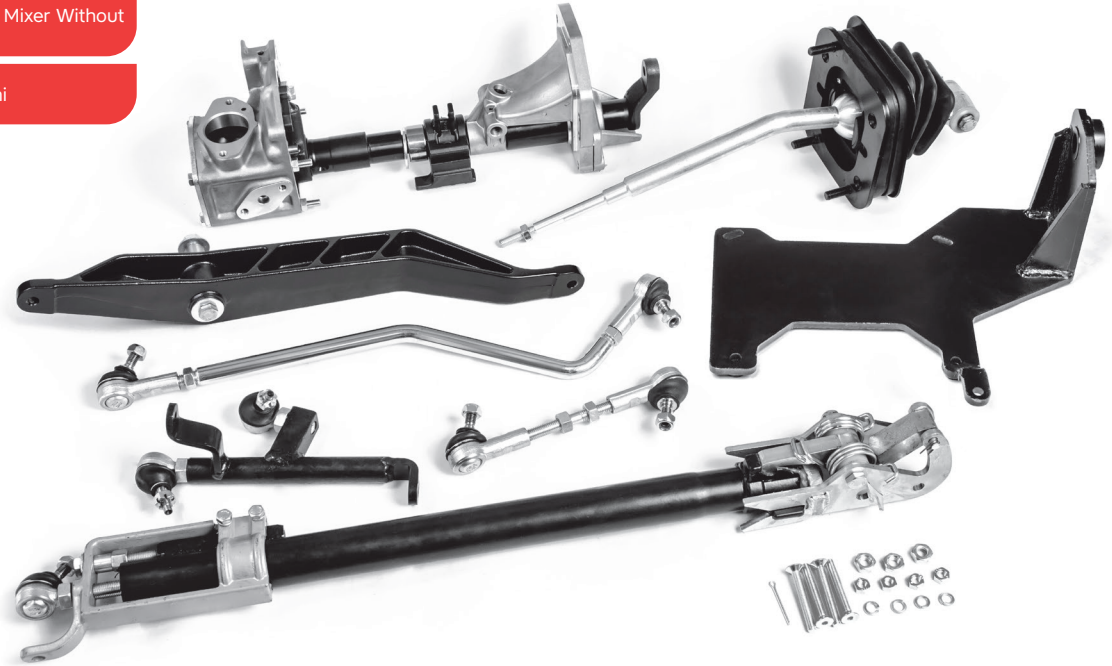

Gear Lever Assy

Vites Kolu Takımları

CK18.0260

Gear Lever Assy G155 with Valve

G155 Kule Boru Ve Hava Ventili Dahil

**INCLUDE
VALVES**

CK18.0261

Gear Lever Assy G155 without Valve

G155 Kule Ve Boru



CK18.0270

Actros Bus GS Automatic Gear Lever
Assy with Valves Electric Model

Actros Otobüs GS Otomatik kule Boru ve
Ventil Dahil Elektrikli Model



INCLUDE
VALVES

CK18.0271

Actros Bus GS Automatic Gear Lever
Assy Electric Model

Actros Otobüs GS Otomatik kule ve Boru
Elektrikli Model



Gear Lever Assy

Vites Kolu Takımları

CK18.0272

Actros Bus GS Automatic Gear Lever
Assy with Valves Mechanic Model

Actros Otobüs GS Otomatik kule Boru ve
Ventil Dahil Kibritli Model

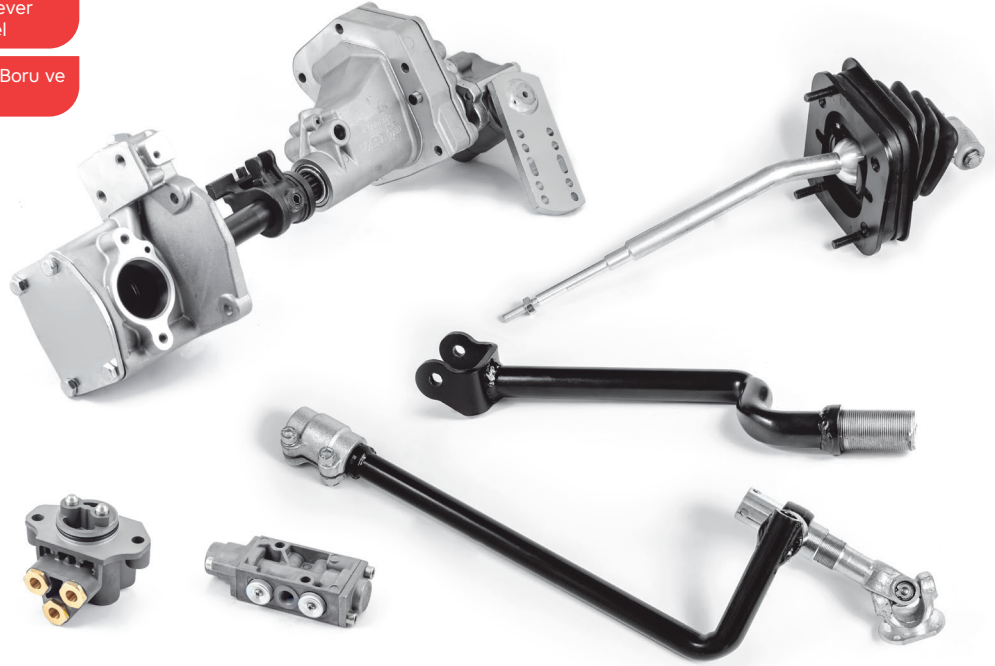

INCLUDE
VALVES

CK18.0273

Actros Bus GS Automatic Gear Lever
Assy Mechanic Model

Actros Otobüs GS Otomatik kule ve Boru
Kibritli Model



CK18.0274

Actros Bus MP1 Gear Lever Assy with Valves Electric Model

Actros Otobüs MP1 kule Boru ve Ventil Dahil Elektrikli Model



INCLUDE
VALVES

CK18.0275

Actros Bus MP1 Gear Lever Assy Electric Model

Actros Otobüs MP1 kule ve Boru Elektrikli Model



Gear Lever Assy

Vites Kolu Takımları

CK18.0276

Actros Bus MP1 Gear Lever Assy with Valves Mechanic Model

Actros Otobüs MP1 kule Boru ve Ventil Dahil Kibritli Model

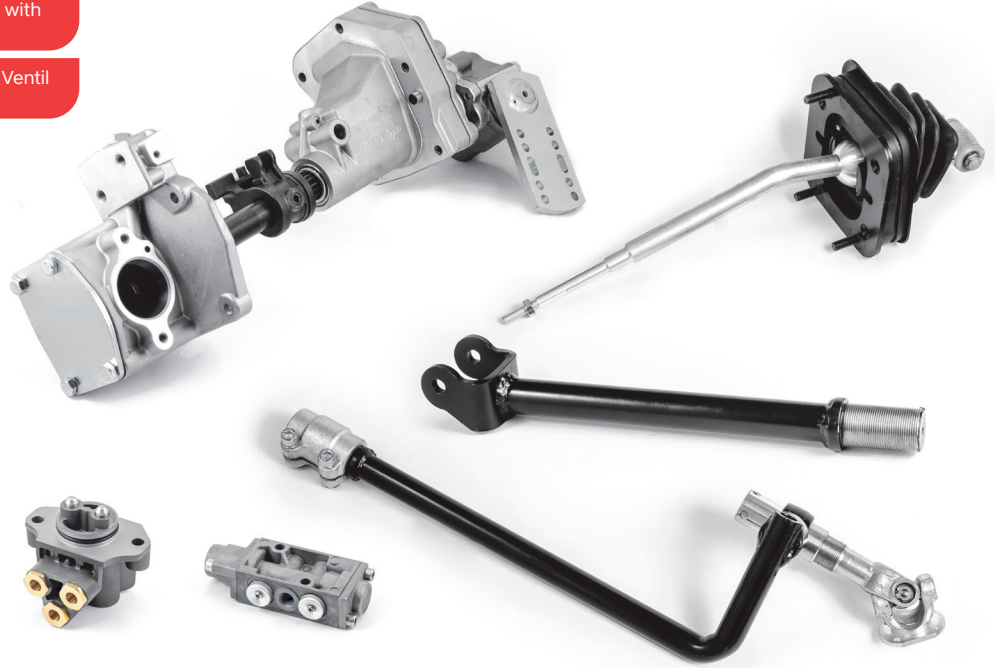

INCLUDE
VALVES

CK18.0277

Actros Bus MP1 Gear Lever Assy Mechanic Model

Actros Otobüs MP1 kule ve Boru Kibritli Model



CK18.0278

Actros Bus MP2 MP2 Gear Lever Assy
with Valves Electric Model

Actros Otobüs MP2 MP3 kule Boru ve
Ventil Dahil Elektrikli Model



INCLUDE
VALVES

CK18.0279

Actros Bus MP2 MP2 Gear Lever Assy
Electric Model

Actros Otobüs MP2 MP3 kule ve Boru
Elektrikli Model

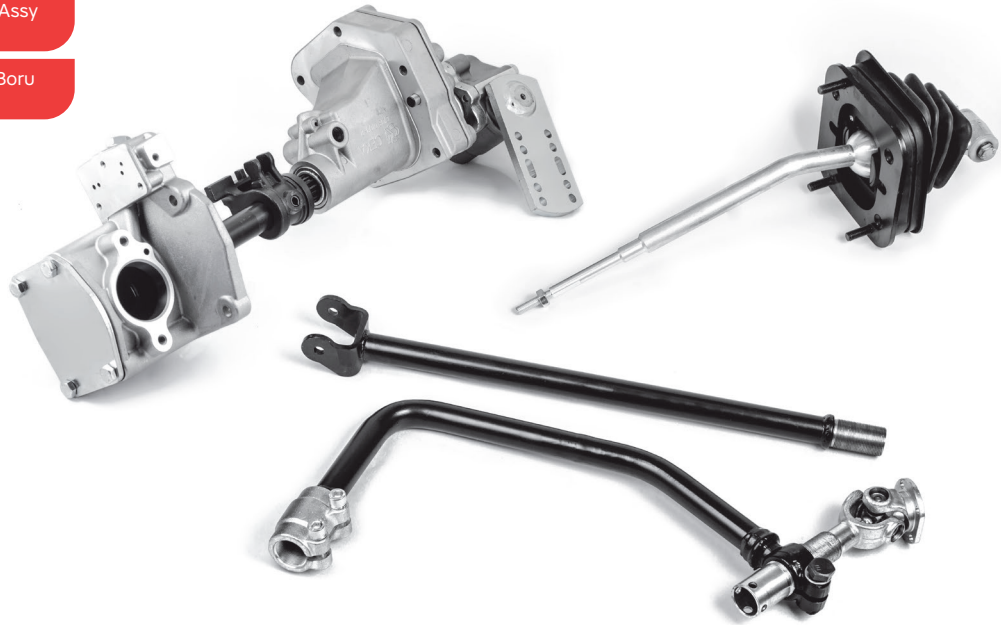

Gear Lever Assy

Vites Kolu Takımları

CK18.0280

Actros Bus MP2 MP2 Gear Lever Assy
with Valves Mechanic Model

Actros Otobüs MP2 MP3 kule Boru ve
Ventil Dahil Kibritli Model



INCLUDE
VALVES

CK18.0281

Actros Bus MP2 MP2 Gear Lever Assy
Mechanic Model

Actros Otobüs MP2 MP3 kule ve Boru
Kibritli Model



Conversion Kits

Kule Takımları



CONVERSION KITS

KULE TAKIMLARI

CK18.0100

Conversion Kit G155

Kule G155

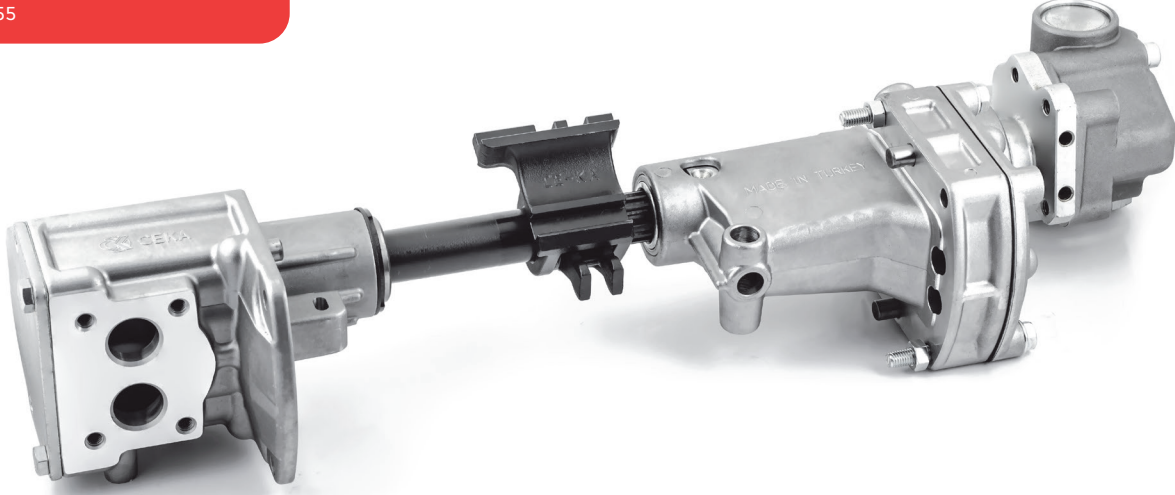

6552600198

CK18.0101

Conversion Kit G155 G180 9 GEARS

Kule G155 180-9VİTES

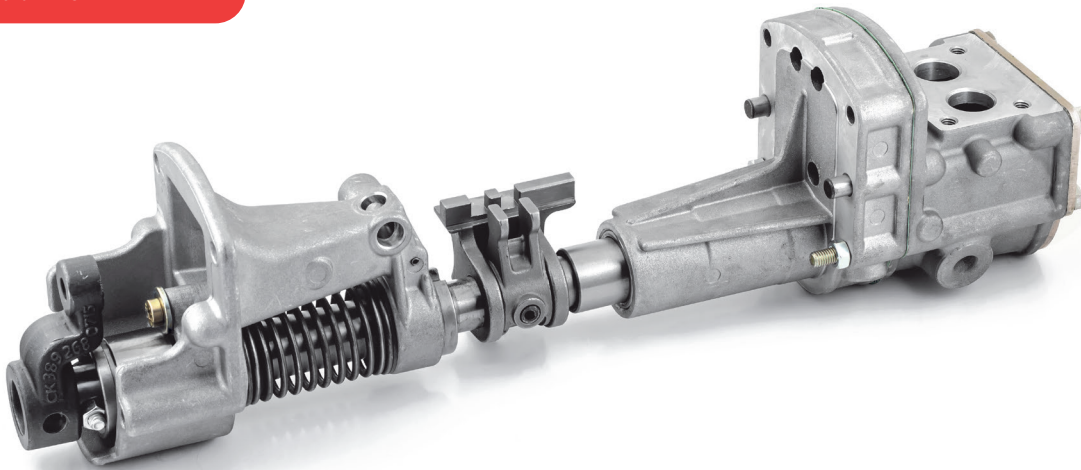

6552600178

Conversion Kits

Kule Takımları

CK18.0102

Conversion Kit G240

Kule G240

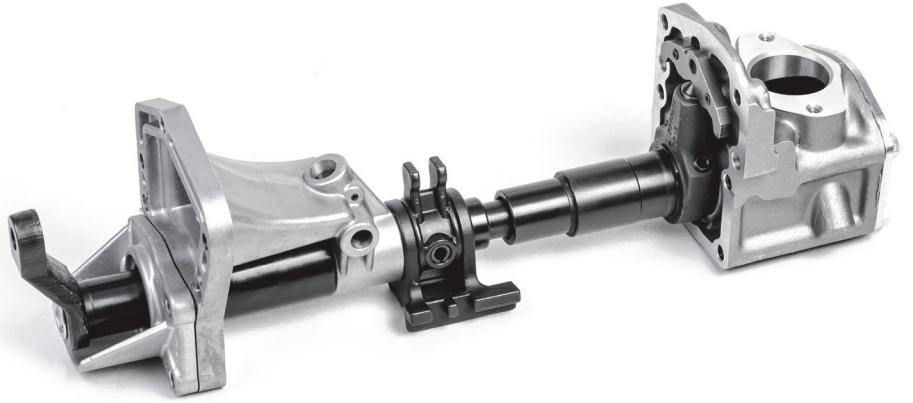

9452609998

9452609898

CK18.0105

Conversion Kit G240 2 Holes Shaft

Kule G240 2 Delikli Mil

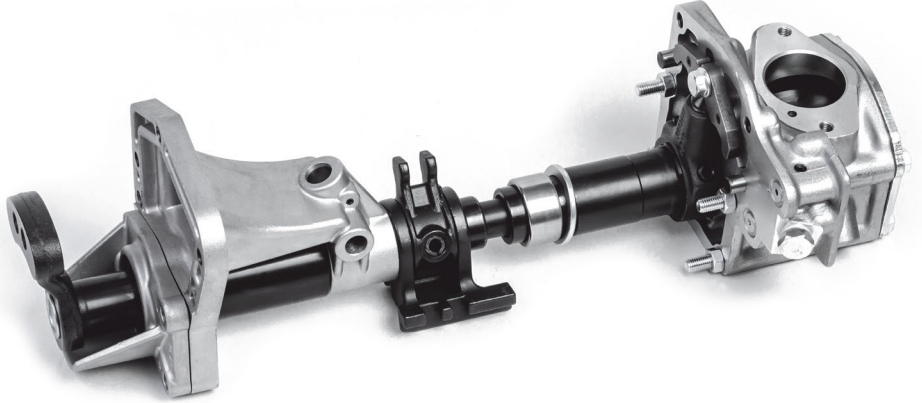

9452609998

9452609898

CK18.0106

Conversion Kit G131

kule G131

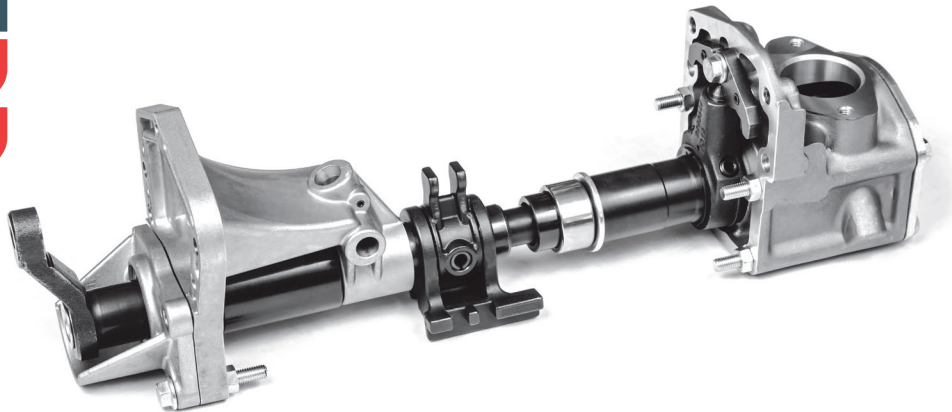

CK18.0103

Conversion Kit G240
CEKA Electric Model

CEKA KULE Elektrikli

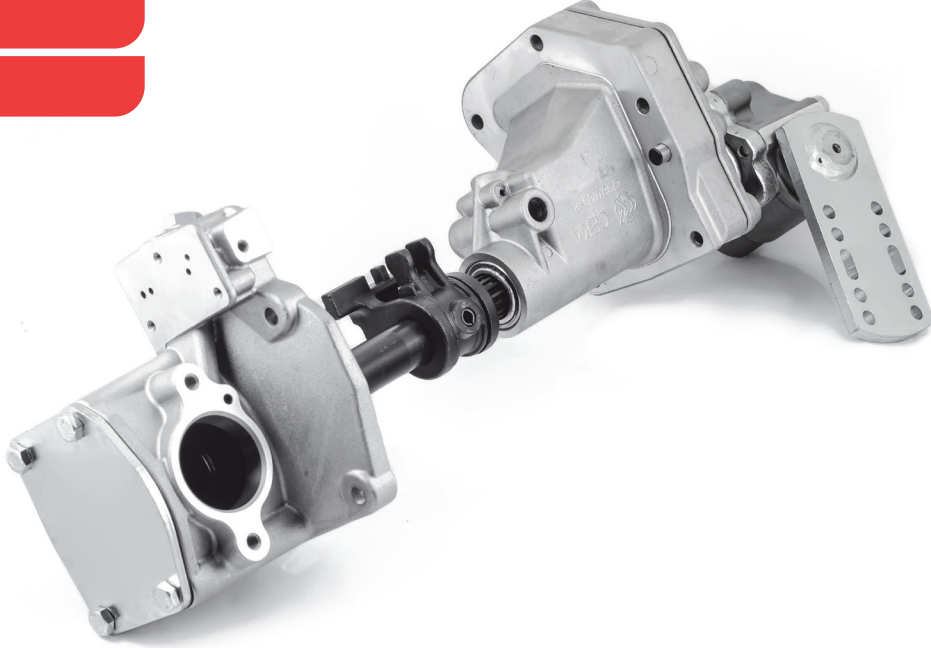

CK18.0104

Conversion Kit G240
CEKA Mechanic Model

CEKA KULE Kibritli

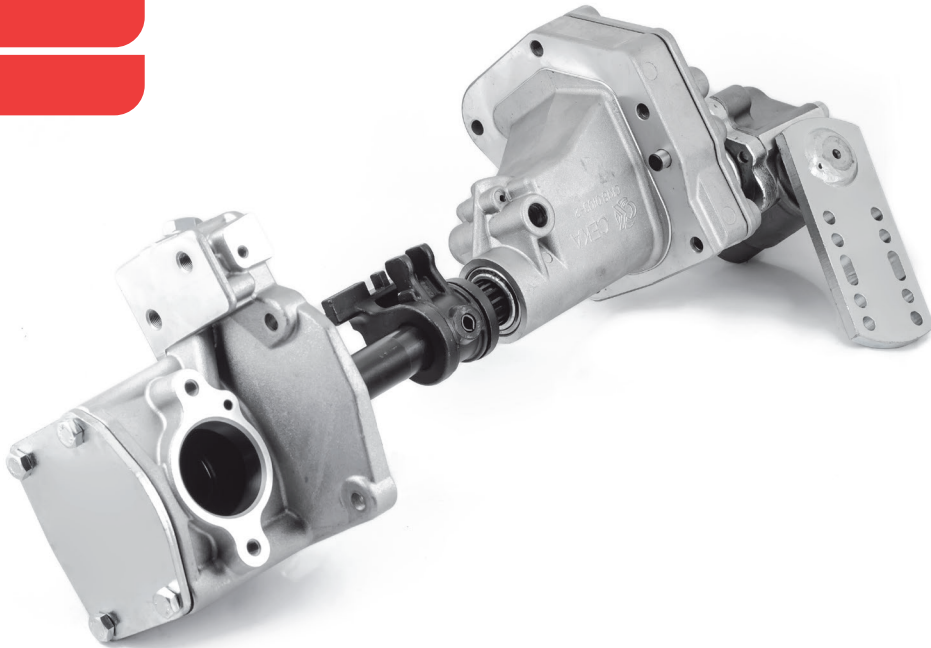

Gear Linkage System

Vites Kolu Baęlantıları



GEAR LINKAGE SYSTEM VİTES KOLU BAęLANTILARI

CK18.0102-2

Gear Linkage System G240

G240 VİTES BORUSU

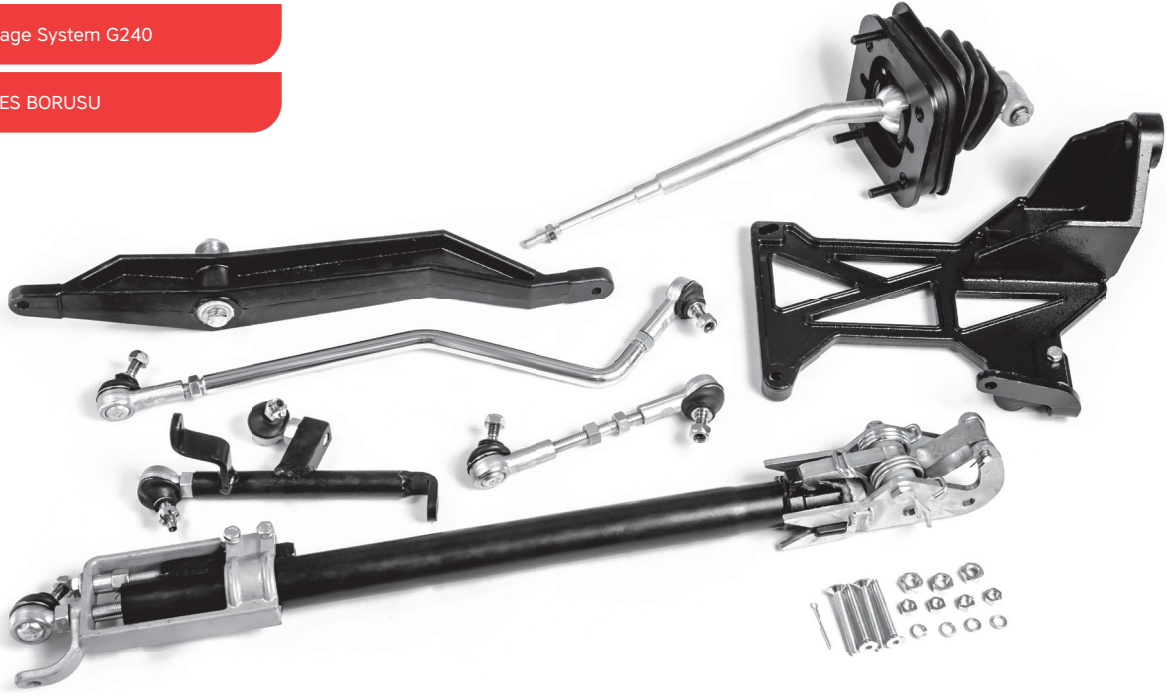

CK18.0100-1

Gear Linkage System G155 Wide Cabin

G155 VİTES BORUSU GENİŞ KABİN



Gear Linkage System

Vites Kolu Bařlantıları

CK18.0100-3

Gear Linkage System G155
NARROW CABIN

G155 VİTES BORUSU DAR KABİN



CK18.0100-4

Gear Linkage System G155 LEXUS V1

G155 VİTES BORUSU LEXUS V1



CK18.0100-5

Gear Linkage System G155 LEXUS V2

G155 VİTES BORUSU LEXUS V2



CK18.0103-6

Gear Linkage System CEKA V6

CEKA VİTES Borsu Set V6

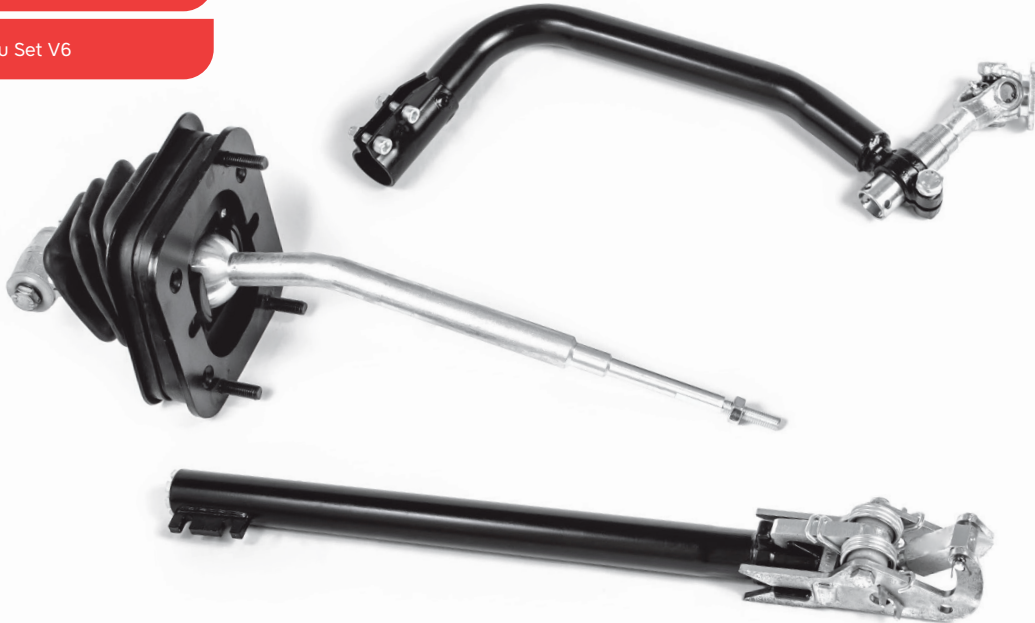

Gear Linkage System

Vites Kolu Bağlantıları

CK18.0103-8

Gear Linkage System CEKA V8

CEKA VİTES Borsu Set V8



CK23.0190

Gear Linkage System
ZF NARROW CABIN

ZF VİTES BORUSU DAR KABİN



CK23.0191

Gear Linkage System
ZF Wide CABIN

ZF VİTES BORUSU GENİŞ KABİN



CK18.0103-4

Gear Linkage System GS Automatic

Otobüs VİTES Borusu GS Otomatik



CK18.0103-5

Gear Linkage System MP1

Otobüs VİTES Borusu MP1



CK18.0103-7

Gear Linkage System MP2 MP3

Otobüs VİTES Borusu MP2 MP3



CK18.0103-9

Shifting Rod Assy V8

Teleskop V8



Gear Linkage System

Vites Kolu Bağlantıları

CK18.0243

Shifting Rod Assy V6

Teleskop V6



9452604833

CK18.0246

Shifting Rod Assy V8

Teleskop V8



9452604933

CK18.0268

Shifting Rod Assy

Teleskop G155



3852609433

CK18.0247

Shifting Cylinder Gear Rod

Piston



9412600063 - 3852600063 - 3852600563

CK18.0264

Shifting Rod Lexus V1 CK18.0100-4

Dirsek Lexus V1 CK18.0100-4



3982680025

CK18.0265

Shifting Rod Lexus V2 CK18.0100-5

Dirsek Lexus V2 CK18.0100-5



6552600233

CK18.0267

Shifting Rod CK18.0100-1

Dirsek CK18.0100-1



6522606633

CK18.0266

Shifting Rod CK18.0100-3

Dirsek CK18.0100-3



3892609933

Gear Linkage System

Vites Kolu Bařlantıları

CK23.0190-1

Shifting Rod ZF CK23.0190

ZF Dirsek Dar Kabin



6452600282

CK23.0191-1

Shifting Rod ZF CK23.0191

ZF Dirsek Geniř Kabin



6202608547

CK18.0262

Joint for Shifting Rod G155

G155 Mafsal

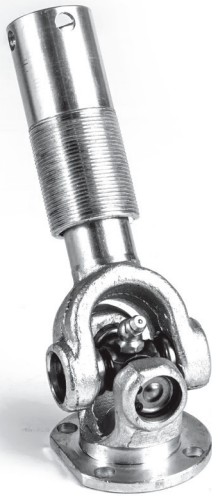

0002686489 - 3872680089

CK18.0262-1

Joint pinion

İstavroz

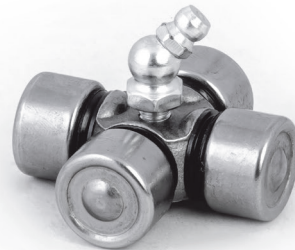

6552600439 - 6522601339

CK18.0263

Shift Lever Actuator G155

G155 Vites Kolu



6552600439 - 6522601339

CK23.0190-2

Shift Lever Actuator ZF Short Model

ZF Vites Kolu Model kısa



3852606039 - 3852607439

CK18.0242

Gear Shift Lever LHD

Vites Kolu

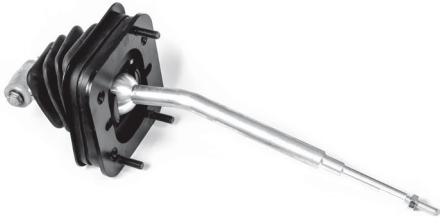

9302609839

CK18.0242-1

Gear Shift Lever LHD REPAIR KIT

Vites Kolu Tamir Takım



CK18.0242-2

Gear Shift Lever LHD

Vites Kolu



9302609839

G240 Conversion Kit Spare Parts

G240 Kule
Yedek Parçaları

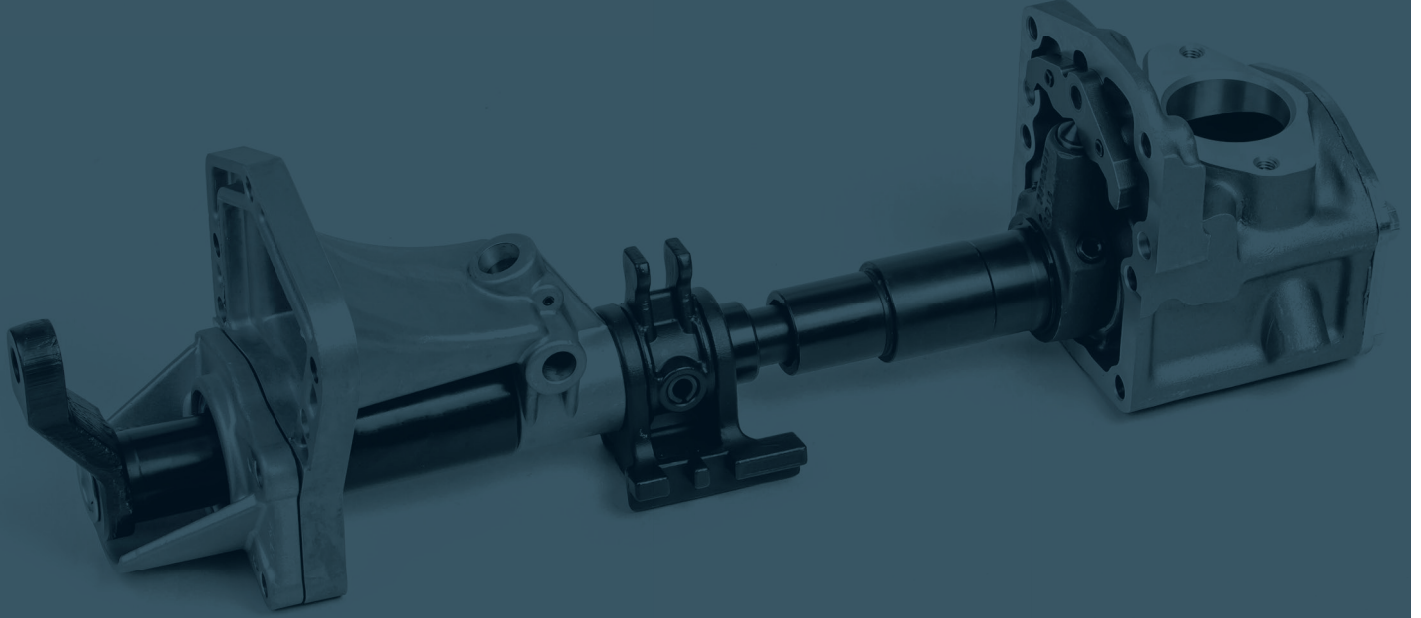

G240

Conversion Kit Spare Parts

KULE Yedek Parçaları

CK18.0194

Bearing Cover

KULE ANA GÖVDE

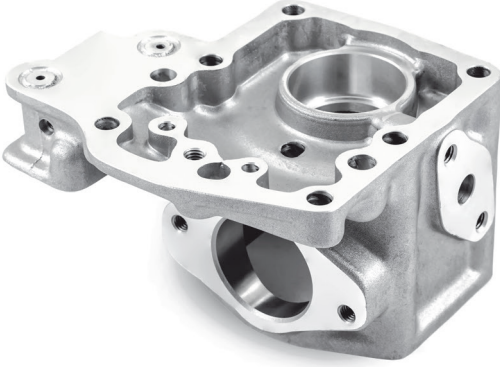

9452681334 - 9452684934 - 9452684334

CK18.0197

Bearing Cover Assy G240

240 MİL GÖVDESİ
945 268 06 34 DÖKÜM NUMARASI



9452684634 - 9452682834 - 9452604713

CK18.0196

Bearing Cover Assy

YAN KAPAK

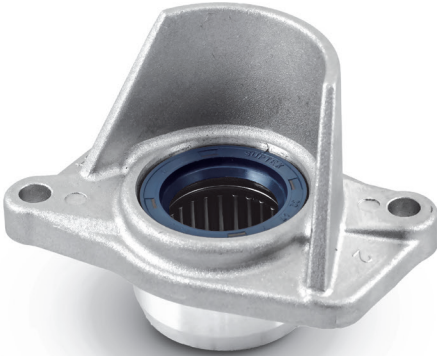

9452682934 - 9452604713

CK18.0143

Sleeve Assy

Frezeli Kovan



9452681025 - 9452680425

G240 Conversion Kit Spare Parts

G240 Kule
Yedek Parçaları

CK18.0131

Shifting Rod

Vites Kolu



9452608333

CK18.0132

Shifting Rod

Vites Kolu



9452600733

CK18.0198

Bushing shift ball lock 82 33

82 33 MİLİN ÜSTÜNDEKİ BİLYA BORUSU



9452682650 - 9452680250 - 9452682950

CK18.0193

Shifting finger EPS

VİTES PARMAGI



9452680133 - 9452680233 - 9452680833

CK18.0192

Pawl MPS-HPS

KILITLEME MEKANİZMASI

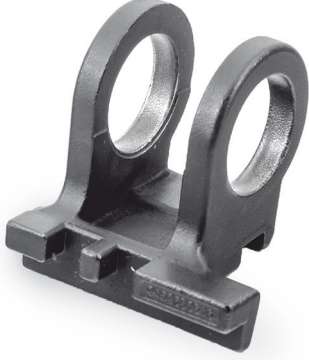

9452680516

CK18.0140

Shifting Segment Range Group Valve
MPS

G240 EKSANTİRİK



9452680046

CK18.0141-1

Detent For Short Pin

Kumanda Yuvası Kısa Pim



9452680746

CK18.0159-4

Pin Assy G240

G240 KULE TAMİR TAKIMI



G240 Conversion Kit Spare Parts

G240 Kule
Yedek Parçaları

CK18.0159-1

Pin

Kule Mili Fişegi



9452681474

CK18.0159-3

pin Bushing

Kule Mili Fişek Burcu



9452682250

CK18.0159-2

Pin Spring

Kule Mili Fişek Yayı



9459933901

CK18.0139

Shifting Segment

Kumanda Yuvası

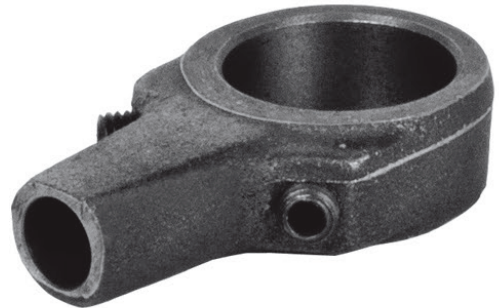

9452680013 - 3892680446

CK18.0140-0

Selector Pin

Kumanda Fişegi



3872680974

CK18.0140-2

Big Spring

Büyük Yay



3879932201

CK18.0140-3

Small Spring

Küçük Yay



3879932101

CK18.0131-1

SHAFT CAP 83 33

MİL TAPASI



3892611733

G240 Conversion Kit Spare Parts

G240 Kule
Yedek Parçaları

CK18.0151-1

Cover Cap

GÖVDE TAPASI



3892611433

CK18.0196-1

Oil Seal

KEÇE



CK18.0150-1

Bearing HK 38-20

HK 38-20 İĞNELİ RULMAN



0079812110

CK18.0149-1

Bearing HK 32-20

İĞNELİ RULMAN HK 32-20 BİLYA



0099810510

CK18.0209

G240 COVER

G240 Kule Saç Kapak



9452680357 - 9452680057

CK18.0210

G240 Pin

G240 VİTES KİLİTLEME PİMİ



9452680174

CK18.0212

G240 WASHER

G240 VİTES ATLATMA AYAR PULU



9762680076

CEKA Conversion Kit Spare Parts

CEKA Kule
Yedek Parçaları

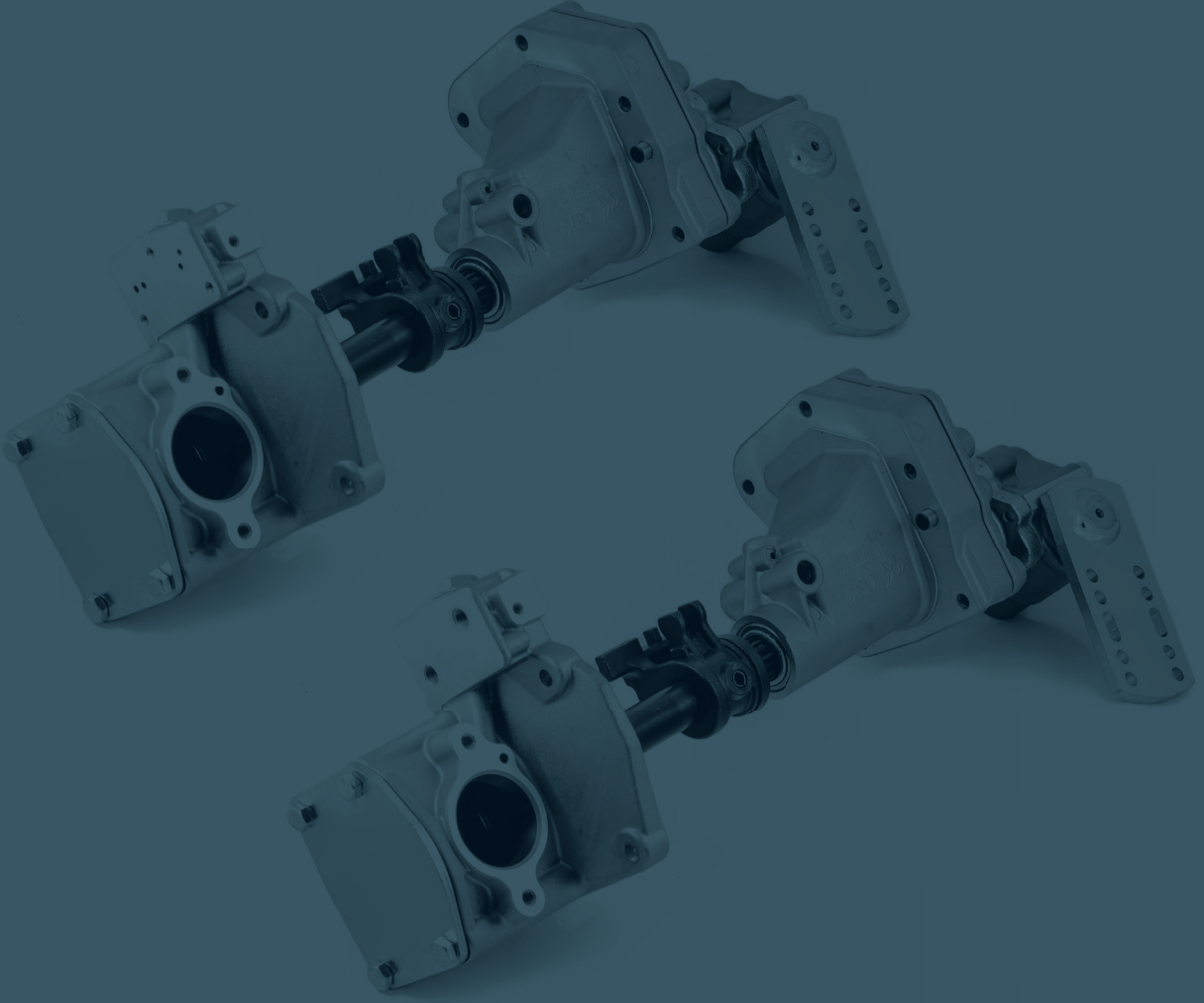

CEKA

Conversion Kit Spare Parts

KULE Yedek Parçaları

CK18.0103-1

Conversion Kit Main Cover
CEKA Electric Model

ANA GÖVDE ELEKTİRİKLİ

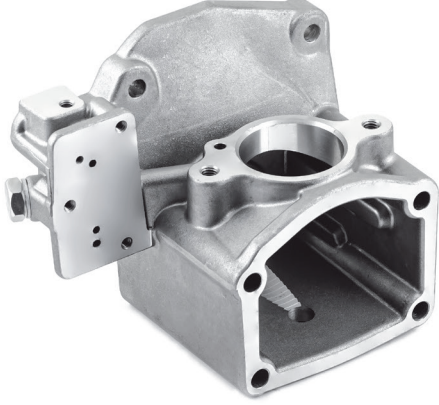

CK18.0104-1

Conversion Kit Main Cover
CEKA Mechanic Model

ANA GÖVDE KİBRİTLİ

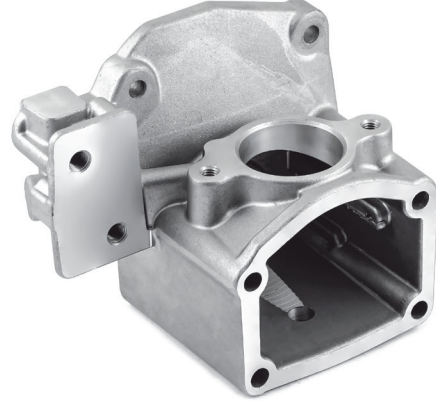

CK18.0103-2

Conversion Kit Cover
CEKA Electric Model

GÖVDE



CK18.0103-3

Conversion Kit Cover CEKA Model

KAPAK



CEKA Conversion Kit Spare Parts

CEKA Kule
Yedek Parçaları

CK18.0152

Lever Assy

Arama Kapağı



3892680001

CK18.0152-1

Lever Assy Long Model

ARAMA KAPAĞI UZUN



3892680001

CK18.0134

Shifting Rod

Vites Kolu



3892680829

CK18.0152-2

Lever Assy Z Model

ARAMA KAPAĞI ZİKZAK

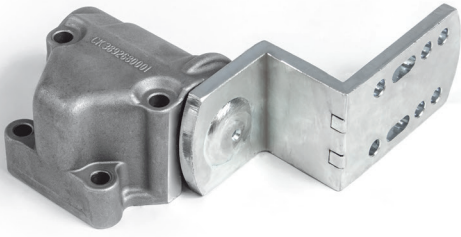

3892680001

CK18.0136

Sleeve Assy

Frezeli Kovan



3892605682

CK18.0144

Bushing

Burç



3892681150

CK18.0192

Pawl MPS-HPS

KILITLEME MEKANİZMASI

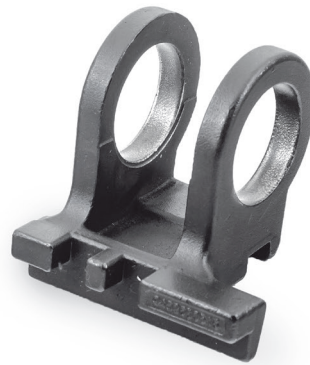

9452680516

CEKA Conversion Kit Spare Parts

CEKA Kule
Yedek Parçaları

CK18.0193

Shifting finger EPS

VITES PARMAGI



9452680133 - 9452680233 - 9452680833

CK18.0140

Shifting Segment Range Group Valve
MPS

G240 EKSANTİRİK



9452680046

CK18.0146

Selector lever module

Seçici Kol



3892650230

CK18.0145

Fork With Pin and Snap Ring

Seçici Mil



3892650216

CK18.0139

Shifting Segment

Kumanda Yuvası

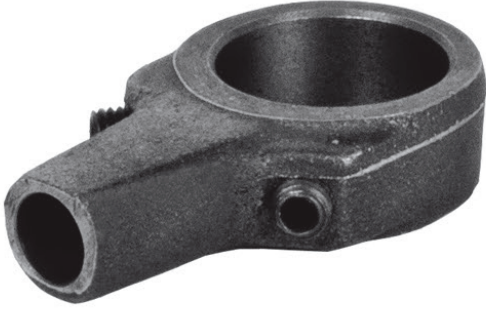

9452680013 - 3892680446

CK18.0140-0

Selector Pin

Kumanda Fişegi



3872680974

CK18.0140-2

Big Spring

Büyük Yay



3879932201

CK18.0140-3

Small Spring

Küçük Yay



3879932101

CEKA Conversion Kit Spare Parts

CEKA Kule
Yedek Parçaları

CK18.0141-2

Detent With Long Pin

Kumanda Yuvası Uzun Pim



9452680746

CK18.0134-1

Shifting Rod REPAIR KIT
G155 G180-16

G155 G180-16 VİTES MİL
TAMİR TAKIMI



CK18.0151-1

Cover Cap

GÖVDE TAPASI



3892611433

CK18.0150-1

Bearing HK 38-20

HK 38-20 İÇNELİ RULMAN



0079812110

CK18.0149-1

Bearing HK 32-20

İĞNELİ RULMAN HK 32-20 BİLYA



0099810510

CK18.0144-1

BEARING HK 25-20

HK 25-20 İĞNELİ RULMAN



0189816110

CK18.0209

G240 COVER

CEKA Kule Saç Kapak



9452680357 - 9452680057

CK18.0213

CEKA Model Pin

CEKA VİTES KİLİTLEME PİMİ



G155 16 Gear Conversion Kit Spare Parts

G155 16 Vites Kule
Yedek Parçaları

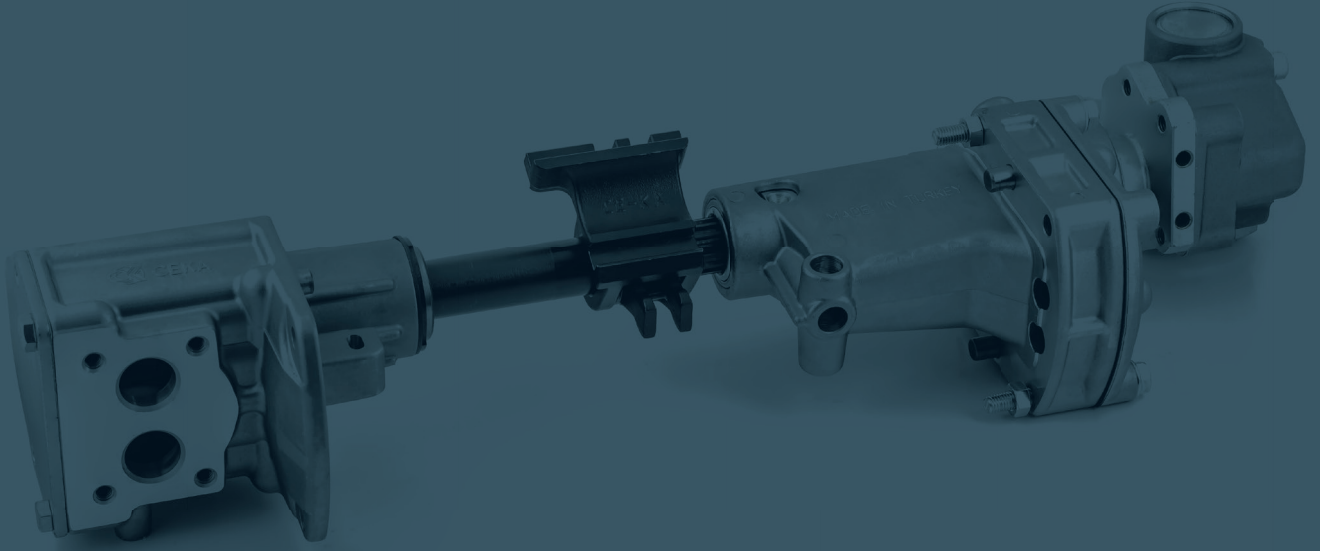

G155 16 Gear

Conversion Kit
Spare Parts

KULE Yedek Parçaları

CK18.0151

Conversion Kit Front Cover

Kule Ana Gövde

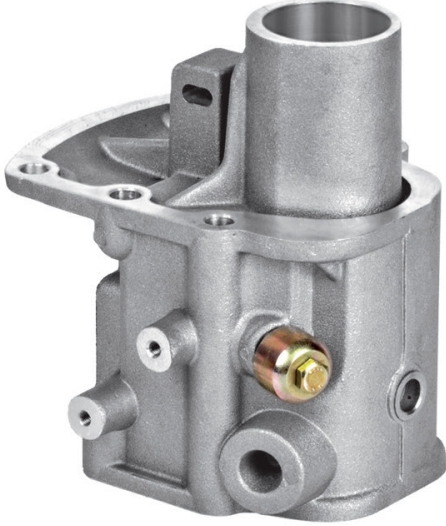

3892681712

CK18.0149

Conversion Kit Cover

Kule Gövde

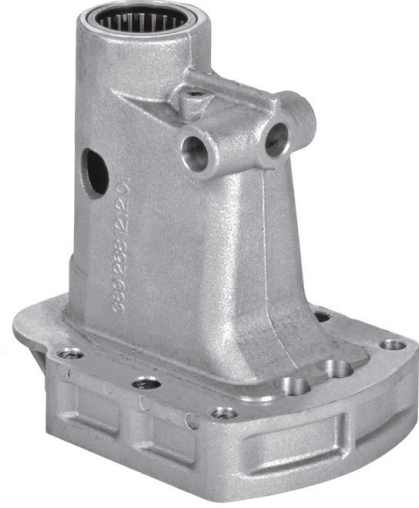

3892681212

CK18.0150

Bearing Cover

Düz Kapak



3892686412 - 3892681334

CK18.0152

Lever Assy

Arama Kapağı



3892680001

G155 16 Gear Conversion Kit Spare Parts

G155 16 Vites Kule
Yedek Parçaları

CK18.0134

Shifting Rod

Vites Kolu



3892680829

CK18.0136

Sleeve Assy

Frezeli Kovan



3892605682

CK18.0148

Pawl Actros

Arama Mandali

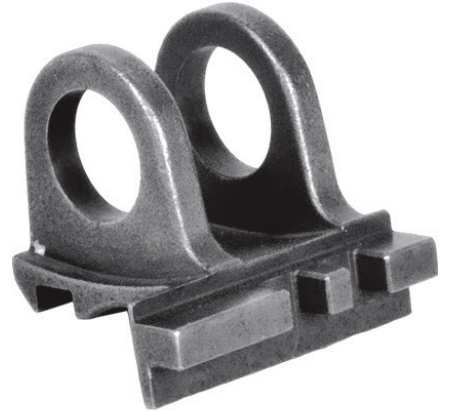

3892682616

CK18.0147

Shifting Finger

Arama Kolu

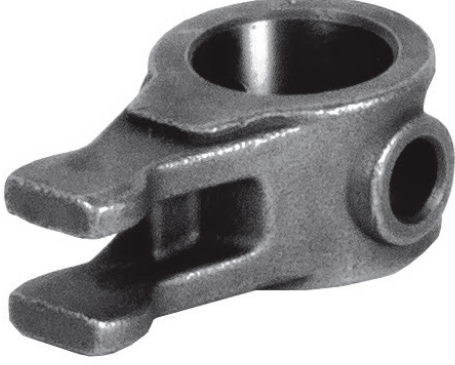

3892680533

CK18.0138

Thrust Piece

Eksantrik



3892670238

CK18.0145

Fork With Pin and Snap Ring

Seçici Mil



3892650216

CK18.0146

Selector lever module

Seçici Kol

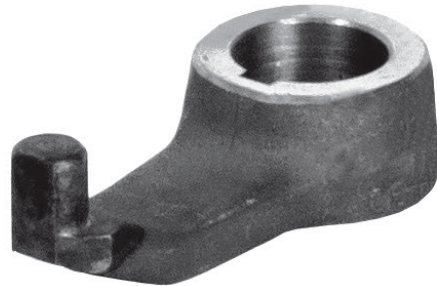

3892650230

G155 16 Gear Conversion Kit Spare Parts

G155 16 Vites Kule
Yedek Parçaları

CK18.0144

Bushing

Burç



3892681150

CK18.0134-1

Shifting Rod REPAIR KIT
G155 G180-16

G155 G180-16 VİTES
MİL TAMİR TAKIMI



CK18.0139

Shifting Segment

Kumanda Yuvası

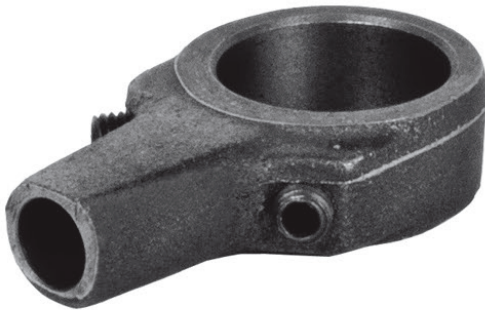

9452680013 - 3892680446

CK18.0140-0

Selector Pin

Kumanda Fişesi



3872680974

CK18.0140-2

Big Spring

Büyük Yay



3879932201

CK18.0140-3

Small Spring

Küçük Yay



3879932101

CK18.0141-2

Detent With Long Pin

Kumanda Yuvası Uzun Pim



9452680746

CK18.0151-1

Cover Cap

GÖVDE TAPASI



3892611433

G155 16 Gear Conversion Kit Spare Parts

G155 16 Vites Kule
Yedek Parçaları

CK18.0150-2

Oil Seal

KEÇE



CK18.0150-1

Bearing HK 38-20

HK 38-20 İĞNELİ RULMAN



0079812110

CK18.0149-1

Bearing HK 32-20

İĞNELİ RULMAN HK 32-20 BİLYA



0099810510

CK18.0144-1

BEARING HK 25-20

HK 25-20 İĞNELİ RULMAN



0189816110

CK18.0214

G155 COVER

G155 KULE SAÇ KAPAK



3892680334

CK18.0215

G155 PIN

G155 VİTES KİLİTLEME PİMİ



3892670474

G155 9 Gear Conversion Kit Spare Parts

G155 9 Vites Kule
Yedek Parçaları

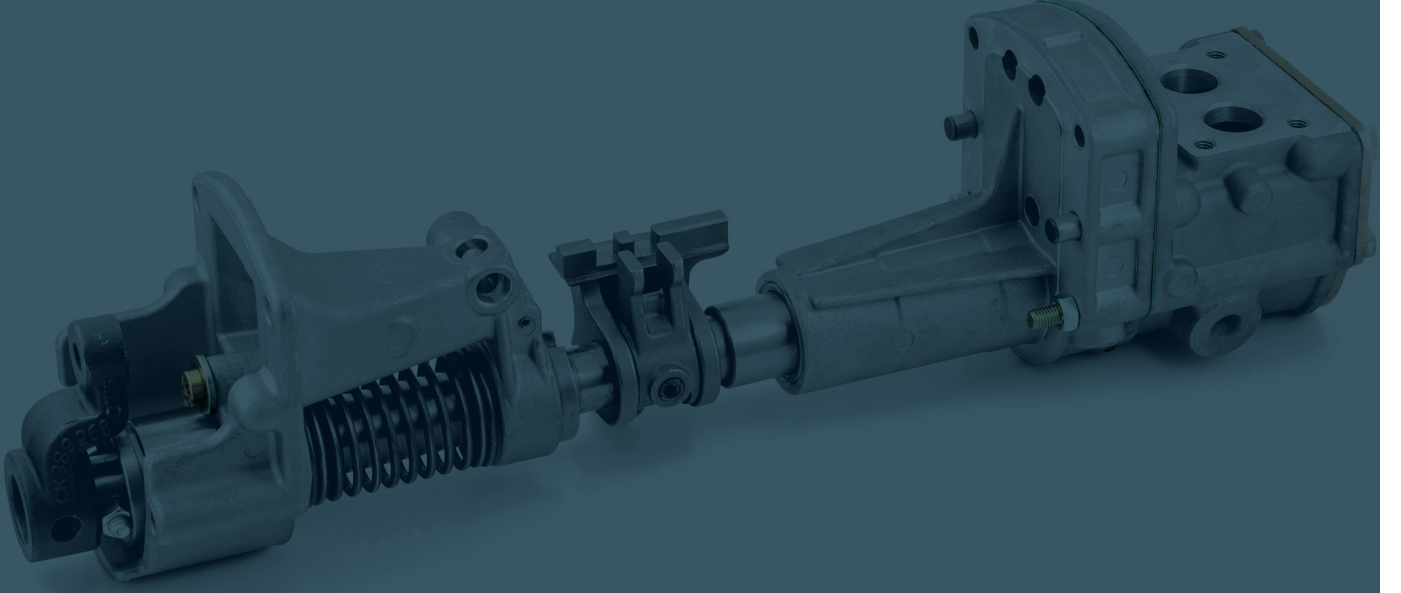

G155 9 Gear

Conversion Kit
Spare Parts

KULE Yedek Parçaları

CK18.0153

Conversion Kit Cover

Kule Gövde

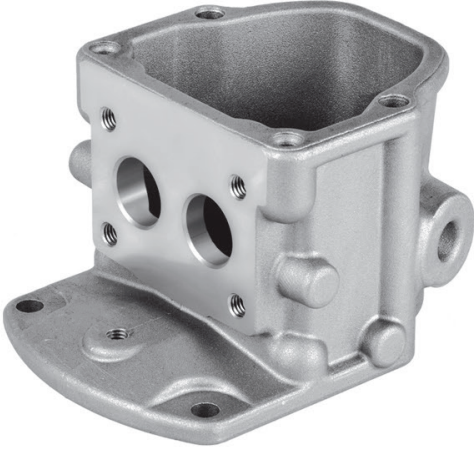

3892688334

CK18.0154

Conversion Kit Cover

Kule Gövde



3892683412

CK18.0155

Conversion Kit Cover

Kule Gövde

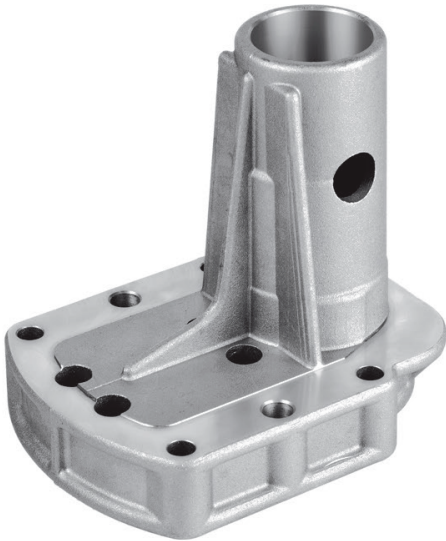

3892683212

CK18.0148

Pawl Actros

Arama Mandali

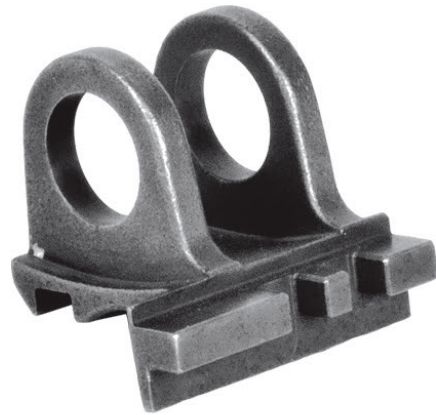

3892682616

G155 9 Gear Conversion Kit Spare Parts

G155 9 Vites Kule
Yedek Parçaları

CK18.0147

Shifting Finger

Arama Kolu



3892680533

CK18.0138

Thrust Piece

Eksantrik



3892670238

CK18.0133

Shifting Rod

Vites Kolu



3892682229

CK18.0137

Sleeve Assy

Frezeli Kovan



3892683650

CK18.0234

Thrust Washer 3031

BURÇ 3031 KULENİN



3892683950

CK18.0235

Conversion Kit Cover REPAIR KIT

GÖVDE TAMİR TAKIMI



CK18.0133-1

Shifting Rod REPAIR KIT G155-180-9

G155-180-9 VİTES MİL TAMİR TAKIMI



G155 9 Gear Conversion Kit Spare Parts

G155 9 Vites Kule
Yedek Parçaları

CK18.230

Shift Lock Bushing

BURÇ 3031 KULENİN



3892681150

CK18.231

Needle Bearing 45-38-20mm

MASURA BİLYA 3031 KULENİN



0179819410

CK18.0233

Oil Seal 3031

KEÇE 3031 KULENİN



0179973647

CK18.0156

Shift Lever MPS

Arama Kolu



3892680715

CK18.0139

Shifting Segment

Kumanda Yuvası

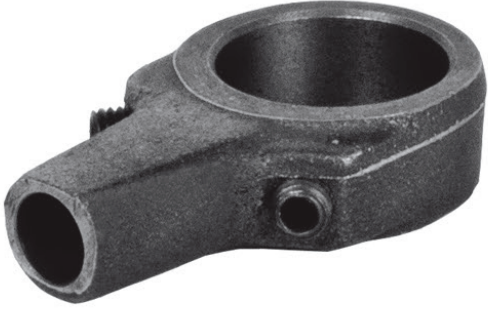

9452680013 - 3892680446

CK18.0140-0

Selector Pin

Kumanda Fişegi



3872680974

CK18.0140-2

Big Spring

Büyük Yay



3879932201

CK18.0140-3

Small Spring

Küçük Yay



3879932101

G155 9 Gear Conversion Kit Spare Parts

G155 9 Vites Kule
Yedek Parçaları

CK18.0141-2

Detent With Long Pin

Kumanda Yuvası Uzun Pim



9452680746

CK18.0151-1

Cover Cap

GÖVDE TAPASI



3892611433

CK18.0150-1

Bearing HK 38-20

HK 38-20 İĞNELİ RULMAN



0079812110

CK18.0149-1

Bearing HK 32-20

İĞNELİ RULMAN HK 32-20 BİLYA



0099810510

CK18.0214

G155 COVER

G155 KULE SAÇ KAPAK



3892680334

CK18.0215

G155 PIN

G155 VİTES KİLİTLEME PİMİ



3892670474

Mercedes-Benz Transmission Spare Parts

Mercedes-Benz
Şanzıman Yedek Parçaları

**MERCEDES-BENZ
TRANSMISSION SPARE PARTS**

**MERCEDES-BENZ
ŞANZIMAN YEDEK PARÇALARI**

CK18.0100-2

GEARBOX Air VALVE G155

AĞIR SERİ VALFİ



0012608457

CK23.0160

4-2way Valve Replaces

TAKVİYE VENTİL-KİBRİT KUTUSU

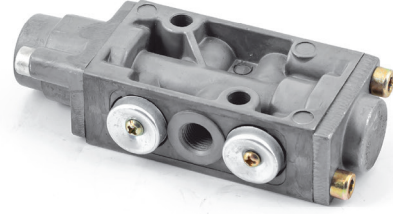

0501310059

CK18.0102-0

Solenoid Valve Actros 2Holes

PİSTON VALVE ELEKTİRİKLİ 2 Delik



9452600057

CK18.0102-1

Solenoid Valve Actros 6Holes

PİSTON VALVE ELEKTİRİKLİ 6 Delik

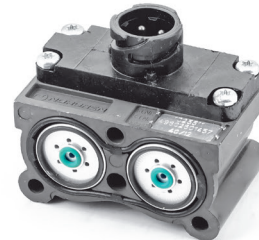

9452601957 - 9602601457 - 9602602757

Mercedes-Benz Transmission Spare Parts

Mercedes-Benz
Şanzıman Yedek Parçaları

CK18.0102-3

GEARBOX Air VALVE G240

ŞANZUMAN VENTİLİ VALF



0022606157 - 0022602357

CK18.0102-4

GEARBOX VALVE G240

ŞANZUMAN VENTİLİ VALF

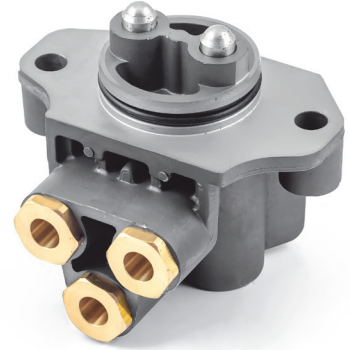

0022606257 - 0022603057 - 0022602957

CK18.0252

Hydraulic Pipe

HORTUM



CK18.0253

FITTING

RAKOR



CK18.0220

Clutch Fork Assy G240

G240 HİLAL TAKIMI-HİLAL KİTİ



9602604130

CK18.0111

3-4 Clutch Fork

3-4 Vites Bağlantı Hilali



9452600830 - 9452650202

CK18.0112

1-2 Clutch Fork G240-211

1-2 Vites Hilali G240-211



9452603630 - 9452603030 - 9452600330 - 9452650301

CK18.0113

3-4 Clutch Fork G240

3-4 Vites Hilali G240



9452650402 - 9452653002

Mercedes-Benz Transmission Spare Parts

Mercedes-Benz
Şanzıman Yedek Parçaları

CK18.0114

1-2-3-4 upper steering linkage

1-2-3-4 Ara Bağlantı Çıtası



9452650232

CK18.0115

upper steering linkage reverse

Geri Vites Bağlantı Çıtası



9452650204 - 9452651104 - 9452650104 - 9452651004

CK18.0116

1-2 Upper Steering Linkage

1-2 Vites Bağlantı Çıtası



9452651304 - 9452650304 - 9452651204

CK18.0117

3-4 Upper Steering Linkage

3-4 Vites Bağlantı Hilal Çıtası



9452650504

CK18.0204

Sled ruler

Kızak Laması



9602600432 - 9602600732

CK18.0118

1-2 Clutch Fork G131 New Model

1-2 Vites Hilali G131 YENİ MODEL



9472602230 - 9472652301

CK18.0119

3-4 Clutch Fork G131 New Model

3-4 Vites Hilali G131 YENİ MODEL

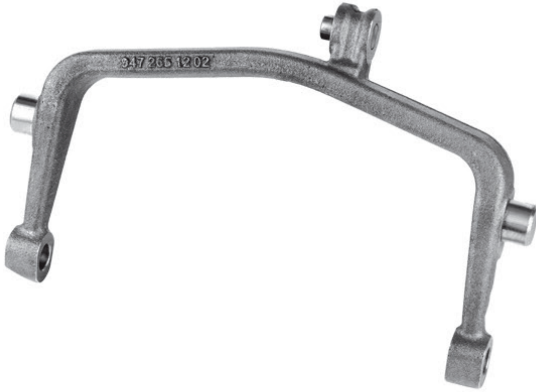

9472651202 - 9472602730 - 9472602530

CK18.0120

1-2 Clutch Fork G131 Old Model

1-2 Vites Hilali G131 ESKİ MODEL



9472650601

Mercedes-Benz Transmission Spare Parts

Mercedes-Benz
Şanzıman Yedek Parçaları

CK18.0121

3-4 Clutch Fork G131 Old Model

3-4 Vites Hilali G131 ESKİ MODEL



9472650802

CK18.0122

Clutch Fork Half

Buçuk Vites Hilali



9452650001

CK18.0123-1

Clutch Fork-Heavy Series New Model

Ağır Seri Hilali YENİ MODEL



9472651901 - 9472650901

CK18.0123-2

Clutch Fork-Heavy Series Old Model

Ağır Seri Hilali ESKİ MODEL



9472650801 - 9472652701 - 9472651701

CK18.0126

3-4 Clutch Fork G211 Tiriptonik

3-4 VİTES HİHALİ G211 TİRİPTONİK



9452602630 - 9452603730 - 9452601030

CK18.0127

Clutch Fork Half

BUÇUK HİHALİ



3892650601

CK18.0128

3-4 Clutch Fork G221-9

3-4 VİTES HİHALİ G221-9



9452651202

CK18.0129

1-2 Clutch Fork G221-9

1-2 VİTES HİHALİ G221-9



Mercedes-Benz Transmission Spare Parts

Mercedes-Benz
Şanzıman Yedek Parçaları

CK18.0201

3-4 Clutch Fork-Bus

3-4 VİTES HİLALİ-OTOBÜS



3892603930 - 3892651702

CK18.0202

5-6 Clutch Fork-G170 G190

5-6 VİTES HİLALİ-G170-190



3892604130 - 3892606630 - 3892651502

CK18.0203

Clutch Fork Without Hole

HİLAL DELİKSİZ

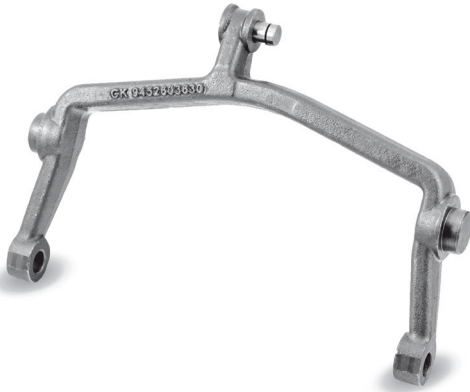

9452650301

CK18.0200

5-6 Clutch Fork G210 G230

5-6 VİTES HİLALİ G210 G230



9472600031 - 9472604330 - 3892605930 - 3892605730

CK18.0211

Clutch Fork Shaft

HİLAL MİLİ



3892652102

CK18.0208

G131 Conversion Kit Front Cover

G131 Kule Ana Gövde

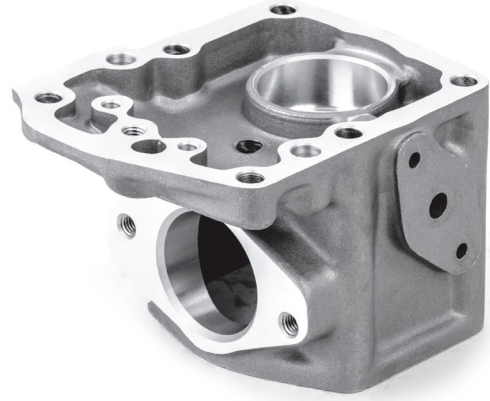

9452685034

CK18.0135

Shifting Rod

Vites Kolu



9452608233

Mercedes-Benz Transmission Spare Parts

Mercedes-Benz
Şanzıman Yedek Parçaları

CK18.0158

Shifting Rod

KULE MİLİ



9452682929

CK18.0236

Conversion Kit Shifting Rod

KULE MİLİ



9452680929

CK18.0159

Shifting Rod G131

G131 KİLİTLEME MİLİ



9472680225 - 9472680525

CK18.0160

Rod for Control-16Gear-G155 G180

KİLİTLEME MİLİ UZUN-16VİTES-G155
G180



3892684825

CK18.0161

Rod for Control G240 G211-16 Gear

G240 G211-16 VİTES Kilitleme Mili-Uzun



9452680225

CK18.0162

Rod for Control G155-9

G155-9 KİLİTLEME MİLİ KISA



3892684925

Mercedes-Benz Transmission Spare Parts

Mercedes-Benz
Şanzıman Yedek Parçaları

CK18.0162-1

Interlock Pin

Ağır Seri Kilitleme Mili



3892670974

CK18.0162-5

Interlock Pin

AĞIR SERİ KİLİTLEME MİLİ



9452670274

CK18.0162-2

Interlock Pin Spring

Ağır Seri Kilitleme Yayı



3899930601

CK18.0162-4

Interlock Pin Spring

Kule Mil Fişek Yayı



3899930501

CK18.0162-3

Interlock Pin Selector

Kilitleme Mil Fişeci



3892680674

CK18.0173

Piston-Control Cylinder

AĞIR SERİ PİSTONU



3892671018 - 3892671118

CK18.0185

Piston-Control Cylinder

AĞIR SERİ PİSTONU



9302670618 - 9602670118

CK18.0186

Piston-Control Cylinder

AĞIR SERİ PİSTONU



3872670918 - 9452670218

Mercedes-Benz Transmission Spare Parts

Mercedes-Benz
Şanzıman Yedek Parçaları**CK18.0172**

Shaft Bushing

Mil Burcu



3872670650

CK18.0174

Piston-Control Cylinder G131

AĞIR SERİ PİSTON MİLİ-G131



3892677317

CK18.0175

Piston-Control Cylinder

AĞIR SERİ PİSTON MİLİ



3892673517

CK18.0176

Piston-Control Cylinder

AĞIR SERİ PİSTON MİLİ



9302670217

CK18.0177

Piston-Control Cylinder

AĞIR SERİ PİSTON MİLİ



9452672117

CK18.0178

Gear Shift Rail

BUÇUK MİLİ



9302670117

CK18.0179

Gear Shift Rail

BUÇUK MİLİ



9452670017

CK18.0180

Piston-Control Cylinder

AĞIR SERİ PİSTON MİLİ



3892677217

Mercedes-Benz Transmission Spare Parts

Mercedes-Benz
Şanzıman Yedek Parçaları

CK18.0181

Piston-Control Cylinder

AĞIR SERİ PİSTON MİLİ



9762670317

CK18.0182

Piston-Control Cylinder

AĞIR SERİ PİSTON MİLİ



9472670117

CK18.0183

Piston-Control Cylinder

AĞIR SERİ PİSTON MİLİ



9452670617

CK18.0184

Piston-Control Cylinder

AĞIR SERİ PİSTON MİLİ



9302672117

CK18.0199

Piston-Shifting Cylinder

NVM GV PİSTONU



9452670619

CK18.0124

Clutch Fork Screw Short Type

Hilal Vidası Kısa Tip



9452652974 - 9452652774 - 9452651274

CK18.0125

Clutch Fork Screw Long Type

Hilal Vidası Uzun Tip



9452652874 - 9452652574 - 9452651374

CK18.0195

Clutch Fork Screw

HİLAL VİDASI



3892650974

Mercedes-Benz Transmission Spare Parts

Mercedes-Benz
Şanzıman Yedek Parçaları

CK18.0171

Differential Adjuster Pipe

Diferansiyel Ayar Borusu



9483530153

CK18.0216

Clutch Fork Screw

KUMANDA FİŞEĞİ BİLYALI



945 268 2074 - 389 268 2374 - 389 268 2974

CK18.0140-1

Selector Pin With Hole

Kumanda Fişegi Delikli



3872680974

CK18.0170

Release Fork Repair Kit-MERCEDES-1pc
Bearing

Debriyaj Tamir Takımı - MERCEDES



0002540335

CK18.0140-4

Selector Pin Angle

KUMANDA FİŞEĞİ AÇILI



CK18.0142

Selector Pin With Hole

TAKVİYE KİLİT FİŞEĞİ



3892671174

CK18.0157

Transmission Case Cover Bus

KEÇE KAPAĞI OTOBÜS



3892614518

CK18.0164

Transmission Case Cover

Keçe Kapağı



9452611118

Mercedes-Benz Transmission Spare Parts

Mercedes-Benz
Şanzıman Yedek Parçaları

CK18.0165

Transmission Case Cover

Keçe Kapağı



3892613318

CK18.0166

Transmission Case Cover

Keçe Kapağı



9452611118

CK18.0163

Transmission Case Cover

Keçe Kapağı

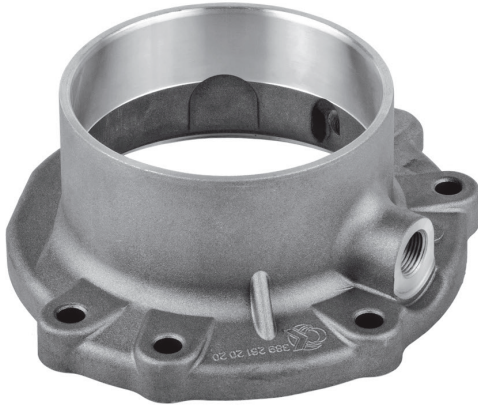

3892612020

CK18.0167

Release Fork-MERCEDES

Debriyaj Çatalı-MERCEDES



6552540708 - 6552501513

CK18.0168

Release Fork Repair Kit-MERCEDES-1Pc
Spindle

Debriyaj Tamir Takımı-MERCEDES



6552540206

CK18.0169

Release Fork Repair Kit-MERCEDES-2Pc
Bushing

Debriyaj Tamir Takımı-MERCEDES



0029921501

CK18.0191

PIN Shaft -Mercedes

HEYKEL PERNOSU MERCEDES



3892620407

CK18.0191-1

PIN Shaft-KL

HEYKEL PERNOSU KL



9472600297 - 9472600197

Mercedes-Benz Transmission Spare Parts

Mercedes-Benz
Şanzıman Yedek Parçaları

CK18.0191-2

PIN Shaft -G131

HEYKEL PERNOSU G131



CK18.0205

Rear Cover Output Flange

DİREKSİYON POMPASI KAPAĞI

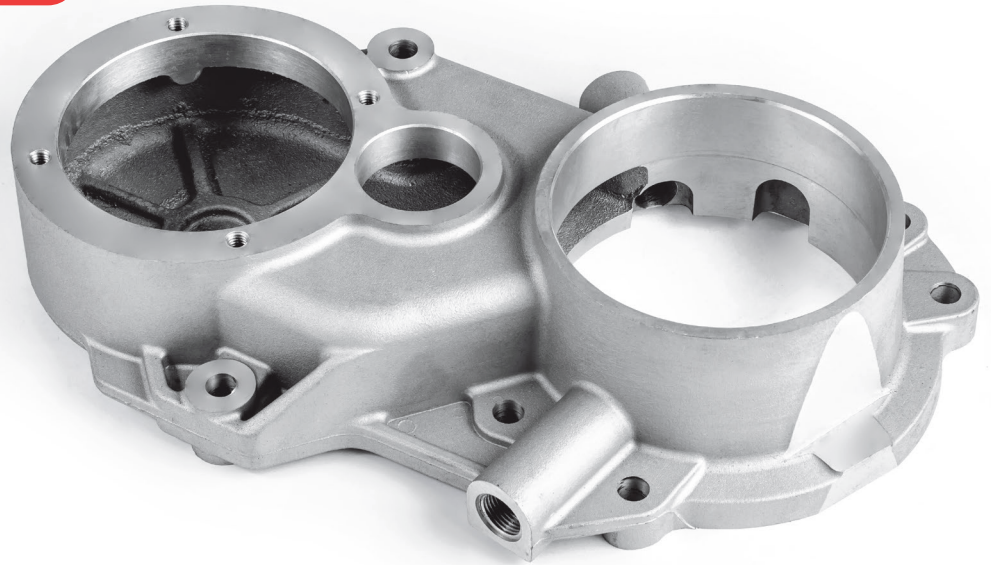

3892611120

CK18.0206

AUTOMATIC TRANSMISSION BRAKE KIT
NEW MODEL

OTOMATİK ŞANZUMAN.FRENLEME
TAKIMI YENİ MODEL

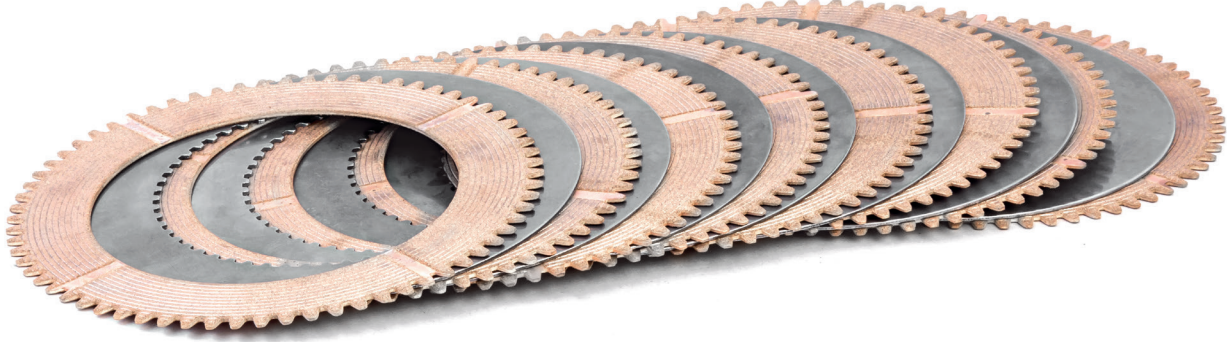

2106254

CK18.0207

AUTOMATIC TRANSMISSION BRAKE KIT
OLD MODEL

OTOMATİK ŞANZUMAN.FRENLEME
TAKIMI ESKİ MODEL

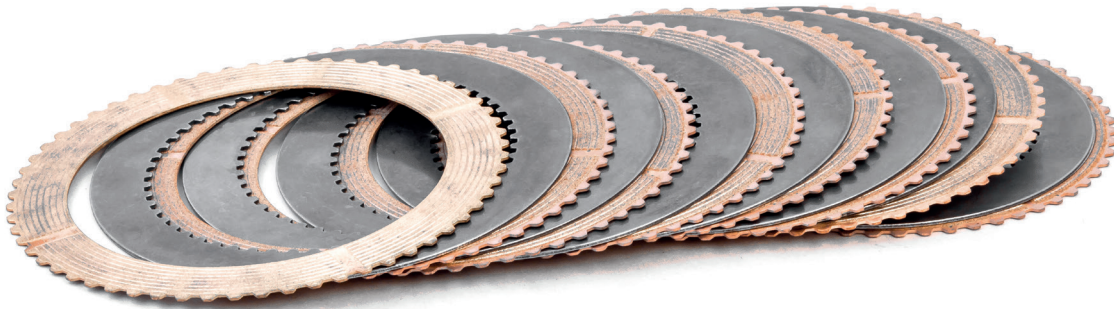

2106255

ZF Transmission Spare Parts

ZF Şanzıman
Yedek Parçaları

**ZF TRANSMISSION
SPARE PARTS**

**ZF ŞANZIMAN
YEDEK PARÇALARI**

CK23.0100

Transmission Case Cover BMC

Keçe Kapağı BMC



1304302316 - 1304402316

CK23.0101

Transmission Case Cover FORD

Keçe Kapağı FORD



1304402319 - 1304302319

CK23.0102

Transmission Case Cover MAN

Keçe Kapağı MAN



1304402213 - 1304302213

CK23.0103

Transmission Case Cover IVECO

Keçe Kapağı IVECO



1315402072 - 1315302072 - 1315202055

ZF Transmission Spare Parts

ZF Şanzıman
Yedek Parçaları

CK23.0104

Transmission Case Cover RENAULT

Keçe Kapağı RENAULT



1315402106 - 1315302106 - 1315202058

CK23.0105

Transmission Case Cover MAN FORD

Keçe Kapağı MAN FORD



1315402134 - 1315302122 - 1315302134 - 1315302061

CK23.0106

Transmission Case Cover
HINO-Ø61mm

Keçe Kapağı HINO-Ø61mm



1315302134 - 1315402134

CK23.0107

Transmission Case Cover DAF

Keçe Kapağı DAF



1315402075 - 1315302075

CK23.0108

Transmission Case Cover MAN

Keçe Kapağı MAN



1315402136 - 1315302136

CK23.0168

Transmission Case Cover FORD

KEÇE KAPAĞI FORD



1315307068

CK23.0109

Front Cover for Bus 109

109luk Ön Gövde Otobüs

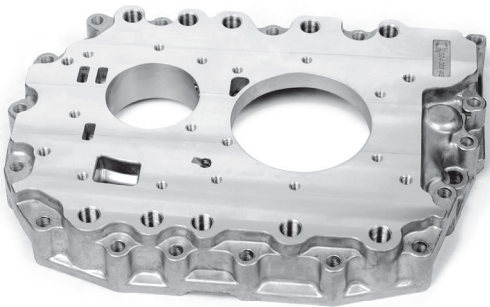

1304301119 - 1304301332 - 1324301169 - 1324301119

CK23.0110

Front Cover 109

109luk Ön Gövde



1304301431 - 1304301331 - 1304301413

ZF Transmission Spare Parts

ZF Şanzıman
Yedek Parçaları

CK23.0111

Release Fork MAN

Debriyaj Çatalı MAN



1315268017 - 81324110007

CK23.0112

Release Fork Housing MAN

Debriyaj Çatalı Yatağı



1315406080 - 1315306080

CK23.0113

Release Fork Repair Kit MAN

Debriyaj Çatalı Tamir Takımı MAN



81305606022

CK23.0114

Shifting Rod ZF DAF

ZF Kule Mili DAF



1315307343

CK23.0115

Shifting Rod ZF Fortuna

ZF Kule Mili Fortuna



1304307474

CK23.0116

Shifting Rod ZF MAN

ZF Kule Mili MAN



1315307264

CK23.0117

Shifting Rod ZF IVECO

ZF Kule Mili IVECO



1315307327

ZF Transmission Spare Parts

CK23.0118

Shifting Rod ZF RENAULT

ZF Kule Mili RENAULT



1315307376

CK23.0119

Shifting Rod ZF FORD

ZF Kule Mili FORD



1304307267

CK23.0120

Shifting Rod ZF MAN

ZF Kule Mili MAN



1304307262

CK23.0121

Shifting Rod ZF - 9 Hole

ZF Kule Mili -9 Delik



1304307266

CK23.0124

Shifting Rod ZF MAN

ZF Kule Mili MAN



1315307094

CK23.0125

Shifting Rod ZF DAF

ZF Kule Mili DAF



1315307249

CK23.0126

Shifting Rod ZF Mercedes

ZF Kule Mili Mercedes



1308307062

CK23.0145

SHIFTING SHAFT Renault

SERVO KULE MİLİ-RENO



1315307438

ZF Transmission Spare Parts

ZF Şanzıman
Yedek Parçaları

CK23.0175

Conversion Kit Shifting Rod 130

ZF KULE MİLİ 130LUK



1295307274

CK23.0176

Conversion Kit Shifting Rod FORD

ZF Kule Mili FORD



1324307260

CK23.0134

Brass bushing 25

25lik Kule Mil Burcu



0730260330

CK23.0135

Brass bushing 28

28lik Kule Mil Burcu



0730260703

CK23.0139

Carrier

Vites Topu



1304307442 - 1304307261

CK23.0140

Carrier

Vites Topu



1315307188 - 1315307733

CK23.0141

Carrier

Vites Topu



1315307333 - 1315307735

CK23.0142

Carrier

Vites Topu

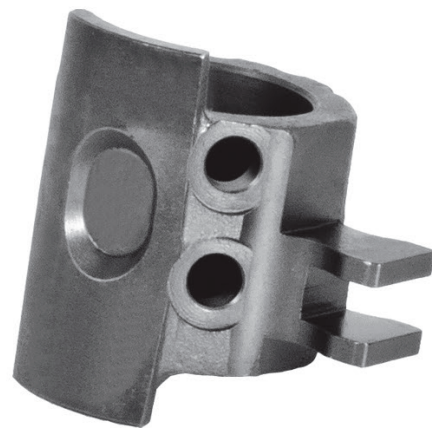

1315307319 - 1315307734

ZF Transmission Spare Parts

ZF Şanzıman
Yedek Parçaları

CK23.0162

Shifting Finger

VİTES ATLATMA MANDALI



1315307395 - 1341307055

CK23.0163

Shifting Finger

VİTES TOPU YENİ



1341307054

CK23.0144

Reverse Gear Bushing

Geri Vites İstinat Burcu



1304307255

CK23.0122

Planet Pin Shaft

Heykel Perno



1315332053

CK23.0123

Planet Pin Shaft

Heykel Perno



1316332096

CK23.0158

PIN Shaft ASTRONİK

HEYKEL PERNOSU ASTRONİK



1358332229 - 1328332014 - 1328332041 - 1358332261

CK23.0159

PIN Shaft

HEYKEL PERNOSU



1304332111

CK23.0123-1

Planet Pin Shaft Bearing

Heykel Perno Bilyası



0750119116

ZF Transmission Spare Parts

ZF Şanzıman
Yedek Parçaları

CK23.0167

PIN Shaft 151

HEYKEL PERNOSU 151 ŞANZIMAN



1315332091

CK23.0166

PIN Shaft 221

HEYKEL PERNOSU 221 ŞANZIMAN



1316332140

CK23.0127

Gearshift Shaft

Vites Topu Borusu



1315307326

CK23.0128

Gearshift Shaft

Vites Topu Borusu



1315307294

CK23.0146

Gearshift Shaft Renault

MİL BORUSU RENO



1315307397

CK23.0164

Gearshift Shaft

VİTES BORUSU YENİ



1341307108

CK23.0165

Gearshift Shaft

VİTES BORUSU YENİ



1315307435

CK23.0129

Shifting Rod Pin

Kule Mili Pimi



0735470126

ZF Transmission Spare Parts

ZF Şanzıman
Yedek Parçaları

CK23.0129-1

Conversion Kit Shaft Pin

KULE MİLİ PİMİ YARGILI



CK23.0136

Selector Pin

Vites Topu Pimi



1316208003

CK23.0137

Pin

Pim



0731201732

CK23.0138

Bearing

Rulman



0635303019

CK23.0133-1

Cover For Spring

KAPAK YAYI



0732040255

CK23.0149

INNER RING 151

4VİTES MASURA BİLYA ÇANAĞI
151 LİK ŞANZIMAN



0750119125

CK23.0150

INNER RING 221

4VİTES MASURA BİLYA ÇANAĞI UZUN
221 ŞANZIMAN



0750119124

CK23.0147

PRESSURE DISC

KAMALI MİL ARKA PUL



1316332109

ZF Transmission Spare Parts

ZF Şanzıman
Yedek Parçaları**CK23.0148**

PRESSURE DISC

KAMALI MİL ARKA PUL



1315332073

CK23.0151

INNER RING 81.45-67.20-4.98mm

4VİTES ÇANAK ALIN PULU-81.45-67.20-4.98mm



0750101158

CK23.0152

INNER RING 81.7-55-7.5MM

KAMALI MİL UÇ BİLYA PULU-81.7-55-7.5MM



1315304043

CK23.0153

INNER RING 81.7-55-7.6MM

KAMALI MİL UÇ BİLYA PULU-81.7-55-7.6MM



1315304044

CK23.0154

INNER RING 81.7-55-7.7MM)

KAMALI MİL UÇ BİLYA PULU-81.7-55-7.7MM)



1315304045

CK23.0155

INNER RING 81.7-55-7.8MM

KAMALI MİL UÇ BİLYA PULU-81.7-55-7.8MM



1315304046

CK23.0156

INNER RING 81.7-55-7.9MM

KAMALI MİL UÇ BİLYA PULU-81.7-55-7.9MM



1315304047

CK23.0157

INNER RING 81.7-55-8MM

KAMALI MİL UÇ BİLYA PULU-81.7-55-8MM



1315304048

ZF Transmission Spare Parts

ZF Şanzıman
Yedek Parçaları

CK23.0170

Shims Kit 4,6MM

EMN-SAC VE PRİZ-KİL-TAK 4,6MM



1499298023

CK23.0171

Shims Kit 4,7 MM

EMN-SAC VE PRİZ-KİL-TAK 4,7 MM



1499298024

CK23.0172

Shims Kit 4,8 MM

EMN-SAC VE PRİZ-KİL-TAK 4,8 MM



1499298025

CK23.0173

Shims Kit 4,9 MM

EMN-SAC VE PRİZ-KİL-TAK 4,9 MM



1499298026

CK23.0174

Shims Kit 5 MM

EMN-SAC VE PRİZ-KİL-TAK 5 MM



1499298027

CK23.0177

Astronik Conversion Kit Pin

ASTRONİK KULE FİŞEK



0731208242

CK23.0161

Piston ZF

PİSTON



1316321016

ZF Transmission Spare Parts

ZF Şanzıman
Yedek Parçaları

CK23.0179

AUTOMATIC TRANSMISSION
BRAKE KIT NEW MODEL ZF

OTOMATİK ŞANZUMAN
FRENLEME TAKIMI YENİ MODEL

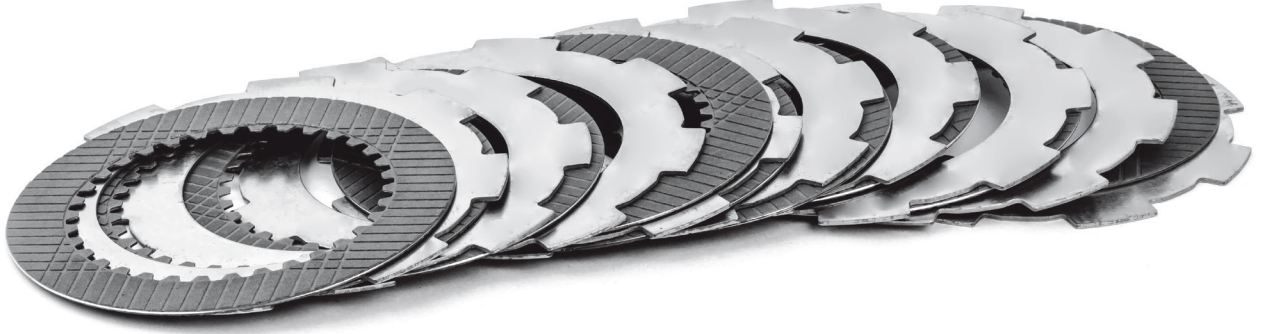

Balata: 0501314215

Lamel: 0501314216

CK23.0180

AUTOMATIC TRANSMISSION
BRAKE KIT OLD MODEL ZF

OTOMATİK ŞANZUMAN
FRENLEME TAKIMI ESKİ MODEL



Balata: 4130210011

Lamel: 1024302050

CK40.0100

Transmission Case Cover VOLVO

Prizdirek Keçe Kapağı VOLVO



1521978 - 20366711

CK40.0101

Release Fork VOLVO

Debriyaj Çatalı VOLVO



8171176 - 8172031

CK40.0100-1

Transmission Case Cover
VOLVO REPAIR KIT

Prizdirek Keçe Kapağı
VOLVO TAMİR TAKIMI



20806212 - 31919671

SCANIA Transmission Spare Parts

SCANIA Şanzıman
Yedek Parçaları

CK30.0100

Transmission Case Cover SCANIA

Keçe Kapağı SCANIA



1490550 - 1515430

CK30.0101

Release Fork SCANIA

Debriyaj Çatalı SCANIA



1479578 - 1737306

CK30.0102

Release Fork Repair Kit SCANIA

Debriyaj Tamir Takımı SCANIA



602582

CK70.001

BEARING BRACKET FRONT LEFT

KABİN KULAĞI-SOL



9408914820 - 9408905283

CK70.002

BEARING BRACKET FRONT RIGHT

KABİN KULAĞI-SAĞ



9408914920 - 9408905383

Puller Kits

Çektirmeler

**PULLERS
KITS
ÇEKTİRMELER**

CK80.001

Main Part For All Puller Kit

Ana Aparat



CK80.002

M85 x M70 Extension For Deep Bearing

Dip Rulman Ara Uzatma M85-M70



CK80.003

M85 x M85 Extension For Input Shaft

Prizdirek Rulman Ara Uzatma M85-M85



CK80.004

M100 x M70 Extension For Main Shaft

M100-M70 Kamalı Mil Arka Rulman Uzatması



Puller Kits

Çektirmeler

CK80.005

M70 x M70 Extention

M70-M70 Ara Uzatma



CK80.101

G240 - G210 First Bearings Puller For Main Shaft

G240 - G210 Kamalı Mil Uç Rulman Çektirmesi



CK80.102

G211 First Bearings Puller For Main Shaft

G211 Kamalı Mil Uç Rulman Çektirmesi



CK80.103

G155-180 First Bearings Puller For Main Shaft

G155 G180 Kamalı Mil Uç Rulman Çektirmesi



CK80.104

G100 First Bearings Puller For
Main Shaft

G100 Kamalı Mil
Uç Rulman Çektirmesi



CK80.105

G240 Gear 4th Puller

G240 4Vites Dişli Çektirmesi



CK80.106

G210-G211-G155-G180 Gear 4th Puller -
KL211 Gear 3th Puller

G210-G211-G155-G180 4-Vites Dişli
Çektirmesi - KL211 3. Vites



CK80.107

G100 Gear 6th Puller

G100 6-Vites Dişli Çektirmesi



Puller Kits

Çektirmeler

CK80.108

G155-211-240 Gear 4th
Bearings Adjustment Part

G155 G211 G240 4 Vites
Rulman Ayar Aparatı



CK80.109

G155-211-240
For Holding Main Shaft

G155 G211 G240 Kamalı Mil
Tutma Aparatı



CK80.110

G240 Deep Bearing Puller
For Gear 4th

G240 4-Vites
Dip Rulman Çektirmesi



CK80.111

G155-G210-G211-G200 Deep Bearing
Puller For Gear 4th

G155 G210 G211 G200 4 Vites
Dip Rulman Çektirmesi



CK80.112

G100 Deep Bearing Puller For Gear 6th

G100 6-Vites Dip Rulman Çektirmesi



CK80.113

G155-211-240 Rear Bearing Puller for Counter Shaft

G155 G211 G240 Grup Mili Arka Rulman Çektirmesi



CK80.114

G155-211-240 Front Bearing Puller for Counter Shaft

G155 G211 G240 Grup Mili Ön Rulman Çektirmesi



CK80.115

G155-211-240 Rear Bearing For Main Shaft

G155 G211 G240 Kamalı Mil Arka Rulman Çektirmesi



Puller Kits

Çektirmeler

CK80.116

G155-G211-G240-G180-G210
Big Bearing For Input Shaft

G155 G211 G240 G180 G210 Prizdirek
Büyük Rulman Çektirmesi



CK80.117

G131 First Bearings Puller
For Main Shaft

G131 Kamalı Mil
Uç Rulman Çektirmesi



CK80.118

Bus / First Bearings Puller
for Main Shaft

Otobüs Kamalı Mil
Uç Rulman



CK80.119

G221 First Bearings Puller
For Main Shaft

G221 Kamalı Mil Uç Bilya Çek.



CK80.120

G100 Big Bearing Fot Input Shaft

G100 Prizdirek Büyük Rul Çek



CK80.121

KL 211 Rear Bearing For Main Shaft

KL 211 Kamalı Arka Rul Çek



CK80.122

KL 211- Deep Bearing Puller For Gear 3rd

KL 211- 3 Vites Dip Rulman



CK80.123

KL 211 Rear Bearing Puller for Counter Shaft

KL 211 Grup Mili Arka Rulman



Puller Kits

Çektirmeler

CK80.124

KL 211 Front Bearing Puller
for Counter Shaft

KL 211 Grup Mili Ön Rulman



CK80.125

KL 330-281-240-211- Rear Bearing
For Main Shaft

KL 330-281-240-211- Kamalı Mil Arka
Rulman



CK80.126

155-180-210-211-240 - RETARDER

Mer155-180-210-211-240-Roterdarlı
Arka Aktarma Çektirmes



CK80.127

KL 281-330-3Head Shaft Gear Puller

KL 281-330-3 CÜ VİTES DİŞLİ ÇEKTİRME



CK80.128

KL 281-330-3 Head Bearing Gear Puller

KL 281-330 - 3.CÜ VİTES
DİP RULMAN ÇEKTİRMESİ



CK80.129

KL 281-330 Rear Bearing Puller for
Counter Shaft

KL 281-330 GRUP
ARKA RULMAN ÇEKTİRMESİ



CK80.201

ZF 151-181-221 First Bearings Puller
For Main Shaft

ZF 151-181-221 Kamalı Mil
Uç Rulman Çektirmesi



CK80.202

ZF 9 S 109- 16 S 109 First Bearings
Puller For Main Shaft

ZF 9 S 109-16 S 109 Kamalı Mil
Uç Rulman Çektirmesi



Puller Kits

Çektirmeler

CK80.203

ZF 151-221 Big Bearing
For Input Shaft

ZF 151-221 Prizdirek
Büyük Rulman Çektirmesi



CK80.204

ZF 151 Rear Bearing
For Main Shaft

ZF 151 Kamalı Mil
Arka Rulman Çektirmesi



CK80.205

ZF 181 - 221 Rear Bearing
For Main Shaft

ZF 181-221 Kamalı Mil
Arka Rulman Çektirmesi



CK80.206

ZF 151-181-221 New Model For Counter
Shaft Front and Rear Bearing

ZF 151-181-221 Yeni Model Gurup Mili
Ön ve Arka Rulman Çektirmesi



CK80.207

ZF 109 Front Bearing Puller
For Counter Shaft

ZF 109 Grup Ön Rulman Çektirmesi



CK80.208

ZF 75 Front Bearing Puller
For Counter Shaft

ZF 75lik Grup Ön Rulman Çektirmesi



CK80.209

ZF 75 First Bearings Puller
For Main Shaft

ZF 75lik Kamalı Mil Uç Rulman Çektirme



CK80.210

ZF 75 Rear Bearing Puller
For Counter Shaft

ZF 75 Grup Arka Rul. Çektirmesi



Puller Kits

Çektirmeler

CK80.211

ZF 151-181-211 Rear Bearing Puller
For Counter Shaft

ZF 151-181-211 Grup Mil Ön Arka Rul İç
Çanak Çektirmesi 1-1 Çarek e Olur



CK80.212

ZF 151-181-221 Shaft Filanc Puller

ZF 151-181-221 Şaft Filanş Çektirmesi



CK80.213

ZF 151-181-221 Planet Gear Carrier
"Differential" Puller

ZF 151-181-221 Heykel Çektirmesi -
Roterdarlıya Da Olur



CK80.214

ZF Astronik Counter Shaft
Front and Back Bearing

ZF Astronik Grup Ön Ve Arka Rul Çek



CK80.220

ZF Gearbox / Collecting Part

ZF Şanzuman Toplama Aparatı



CK80.301

SCANIA First Bearings Puller
For Main Shaft

SCANIA Kamalı Mil Uç Rulman Çektirmesi



CK80.302

SCANIA Gear 3rd Puller

SCANIA 3-Vites Dişli Çektirmesi



CK80.303

SCANIA Deep Bearing Puller
For Gear 3rd

SCANIA 3- Vites Dip Rulman Çektirmesi



Puller Kits

Çektirmeler

CK80.304

SCANIA First Bearings Puller
For Main Shaft

SCANIA K-Mil Uç Rulman



CK80.305

SCANIA First Bearings Puller
For Main Shaft GR/905

SCANIA K-Mil Uç Rulman GR-905



CK80.306

SCANIA "RETARDER"
Big Bearings Puller GRS900

SCANIA RETARDER Büy Rul Çek-GRS900



CK80.307

SCANIA First Bearings Puller
For Counter Shaft

SCANIA Gurup Ön-Rulman Çektirmesi



CK80.308

SCANIA 211 Rear Bearing Puller
For Counter Shaft

SCANIA Gurup Arka Rulman Çektirmesi



CK80.401

VOLVO First Bearings Puller
For Main Shaft

VOLVO Kamalı Mil Uç Rulman Çektirmesi



CK80.402

VOLVO AT. GearBox

VOLVO AT-Şanzuman Seri Senkromeç
Çektirme



CK80.403

VOLVO Gear 3rd Puller

VOLVO 3-Vites Dişli Çektirmesi



Puller Kits

Çektirmeler

CK80.404

VOLVO Deep Bearing Puller
For Gear 3rd

VOLVO 3-Vites Dip Rulman Çektirmesi

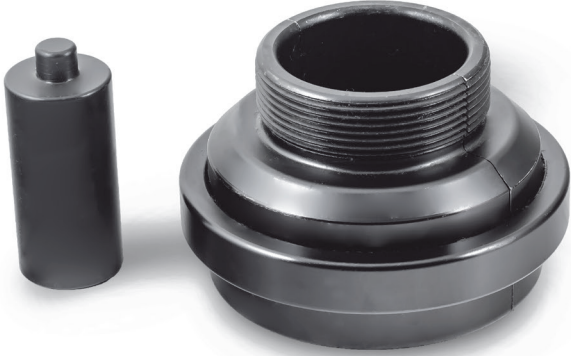

CK80.405

VOLVO First Bearings Puller
For Main Shaft

VOLVO K.Mil Uç Rulman



CK80.406

VOLVO Rear , Front Bearing Puller
For Counter Shaft

VOLVO Gurup Ön Ve Arka Rulman
Çektirmesi



CK80.407

VOLVO Front Bearing Puller
For Counter Shaft

VOLVO Gurup Ön Rulman İnce tip
Çektirmesi



CK80.408

VOLVO Rear Gear Puller
For Main Shaft

VOLVO Kamalı Mil Arka Güneş Dişli Ve
Sekman Pistonu Çek.



CK80.409

VOLVO Front Bearing Puller
For Main Shaft

VOLVO Kamalı Mil Rulman Ve Prizdirek
Ön Rulman Çek.



CK80.410

AT-ATO-2412-2612-2812-3112-3512
Main Shaft and Input Shaft Bearing Puller

AT-ATO-2412-2612-2812-3112-3512
Kamalı Mil Ve Prizdirek Rul Çek.



CK80.411

VT-2412-B Main Shaft and Input Shaft
Bearing Puller-Thin Type Bearing

VT-2412-B Kamalı Mil Ve Prizdirek Rul
Çek-İnce Tip Bilya



Puller Kits

Çektirmeler

CK80.500

Differential Deep Bearing
Puller / Extention

DİF MAĞ DİP RUL ÇEK ARA UZATMA



CK80.501

Differential Deep Bearing Puller.
TGA-AXOR-TREVEGO

TGA-AXSOR-TREVEGO DİF MAĞ DİP
RULMAN ÇEK



CK80.502

Differential Deep Bearing Puller
SCANI-MAN 464-463-423-422

SCANI-MAN 464-463-423-422 DİF MAR
DİP RUL ÇEK



CK80.503

Universal Joints Side Adjustment Bearing
Puller AXOR NO:32020

AXOR İSTAVROZ YAN AYAR BİL ÇEK BİLYA
NO-32020



CK80.504

Universal Joints Side Adjustment Bearing Puller 422/423/463/464

İSTAVROZ YAN AYAR BİL ÇEK.422-423-463-464



CK80.505

Side Adjustment Bearing Puller TGA TGY TGS AXOR RENAULT

TGA TGY TGS AXOR RENAULT YAN AYAR BİL ÇEK



CK80.506

SCANIA Diferansiyel R780/782

SCANIA Diferansiyel Yan Büy Rul Çek Tekçeker R780-782



CK80.507

SCANIA Diferansiyel R780/782

SCANIA Diferansiyel Yan Küç Rul Çek Tekçeker R780-782



Puller Kits

Çektirmeler

CK80.600

Renault 6

RENO 6 TEKER MASKOT ARKA
PORYA LOKMASI TIRNAKLI

CK80.601

Renault 10

RENO 10 TEKER DİPRANSİYEL
PORYA LOKMASI TIRNAKLI

CK80.602

Renault 10 (77 MM)

RENO 10 TEKER DİPRANSİYEL
PORYA LOKMASI 77 MM

CK80.603

Renault-VOLVO (75 MM)

RENO-VOLVO ÖN PORYA
SOMUN LOKMASI 75 MM

CK80.604

Renault-VOLVO (80 MM)

RENO-VOLVO ÖN PORYA
SOMUN LOKMASI 80 MM



CK80.605

Renault-VOLVO (86 MM)

RENO-VOLVO ÖN PORYA
SOMUN LOKMASI 86 MM



CK80.606

Renault-VOLVO (101 MM)

RENO-VOLVO ARKA PORYA SOMUN
LOKMASI 101 MM



CK80.607

Renault-VOLVO (105 MM)

RENO-VOLVO ARKA PORYA SOMUN
LOKMASI 105 MM



Puller Kits

Çektirmeler

CK80.608

Renault-VOLVO (110 MM)

RENO-VOLVO ARKA PORYA
SOMUN LOKMASI 110 MM

CK80.609

Renault-VOLVO (115 MM)

RENO-VOLVO ÖN PORYA
SOMUN KAPAK LOKMASI 115 MM

CK80.610

MAN TGA

MAN TGA ARKA PORYA
SOMUN LOKMASI TIRNAKLI

CK80.611

Mercedes Actros Axor

MERCEDES AKSOR AKTROS ARKA PORYA
SOMUN LOKMASI TIRNAKLI

CK80.612

MAN 422-463-464

MAN 422-463-464 ARKA PORYA
SOMUN LOKMASI TIRNAKLI



Product List

Ürün Listesi

| CEKA NO | OEM | Ürün Tanımı | Product Description | Page |
|-------------|--|-------------------------------------|---|-------------|
| CK18.0100 | 6552600198 | Kule G155 | Conversion Kit G155 | 25 |
| CK18.0100-1 | | G155 VİTES BORUSU GENİŞ KABİN | Gear Linkage System G155 Wide Cabin | 29 |
| CK18.0100-2 | 0012608457 | AĞIR SERİ VALFİ | GEARBOX Air VALVE G155 | 71 |
| CK18.0100-3 | | G155 VİTES BORUSU DAR KABİN | Gear Linkage System G155 NARROW CABIN | 30 |
| CK18.0100-4 | | G155 VİTES BORUSU LEXUS V1 | Gear Linkage System G155 LEXUS V1 | 30 |
| CK18.0100-5 | | G155 VİTES BORUSU LEXUS V2 | Gear Linkage System G155 LEXUS V2 | 31 |
| CK18.0101 | 6552600178 | Kule G155 180-9VİTES | Conversion Kit G155 G180 9GEARS | 25 |
| CK18.0102 | 9452609998 9452609898 | Kule G240 | Conversion Kit G240 | 26 |
| CK18.0102-0 | 9452600057 | PİSTON VALVE ELEKTİRİKLİ 2 Delik | Solenoid Valve Actros 2Holes | 71 |
| CK18.0102-1 | 9452601957 9602601457 9602602757 | PİSTON VALVE ELEKTİRİKLİ 6 Delik | Solenoid Valve Actros 6Holes | 71 |
| CK18.0102-2 | | G240 VİTES BORUSU | Gear Lever Assy G240 | 29 |
| CK18.0102-3 | 0022606157 0022602357 | ŞANZUMAN VENTİLİ VALF | GEARBOX Air VALVE G240 | 72 |
| CK18.0102-4 | 0022606257 0022603057 0022602957 | ŞANZUMAN VENTİLİ VALF | GEARBOX VALVE G240 | 72 |
| CK18.0103 | | CEKA KULE Elektrikli | Conversion Kit G240 CEKA Electric Model | 27 |
| CK18.0103-1 | | ANA GÖVDE ELEKTİRİKLİ | Conversion Kit Main Cover CEKA Electric Model | 47 |
| CK18.0103-2 | | GÖVDE | Conversion Kit Cover CEKA Electric Model | 47 |
| CK18.0103-3 | | KAPAK | Conversion Kit Cover CEKA Model | 47 |
| CK18.0103-4 | | Otobüs VİTES Borsu GS Otomatik | Gear Linkage System GS Automatic | 33 |
| CK18.0103-5 | | Otobüs VİTES Borsu MP1 | Gear Linkage System MP1 | 33 |
| CK18.0103-6 | | CEKA VİTES Borsu Set V6 | Gear Linkage System CEKA V6 | 31 |
| CK18.0103-7 | | Otobüs VİTES Borsu MP2 MP3 | Gear Linkage System MP2 MP3 | 33 |
| CK18.0103-8 | | CEKA VİTES Borsu Set V8 | Gear Linkage System CEKA V8 | 32 |
| CK18.0103-9 | | Teleskop V8 | Shifting Rod Assy V8 | 33 |
| CK18.0104 | | CEKA KULE Kibritli | Conversion Kit G240 CEKA Mechanic Model | 27 |
| CK18.0104-1 | | ANA GÖVDE KİBRİTLİ | Conversion Kit Main Cover CEKA Mechanic Model | 47 |
| CK18.0105 | 9452609998 9452609898 | Kule G240 2 Delik milî | Conversion Kit G240 2Holes Shaft | 26 |
| CK18.0106 | | kule G131 | Conversion Kit G131 | 26 |
| CK18.0111 | 9452600830 9452650202 | 3-4 Vites Bağlantı Hilali | 3-4 Clutch Fork | 73 |
| CK18.0112 | 9452603630 9452603030 9452600330 9452650301 | 1-2 Vites Hilali G240-211 | 1-2 Clutch Fork G240-211 | 73 |
| CK18.0113 | 9452650402 9452653002 | 3-4 Vites Hilali G240 | 3-4 Clutch Fork G240 | 73 |
| CK18.0114 | 9452650232 | 1-2-3-4 Ara Bağlantı Çıtası | 1-2-3-4 upper steering linkage | 74 |
| CK18.0115 | 9452650204 9452651104 9452650104 9452651004 | Geri Vites Bağlantı Çıtası | upper steering linkage reverse | 74 |
| CK18.0116 | 9452651304 9452650304 9452651204 | 1-2 Vites Bağlantı Çıtası | 1-2 Upper Steering Linkage | 74 |
| CK18.0117 | 9452650504 | 3-4 Vites Bağlantı Hilal Çıtası | 3-4 Upper Steering Linkage | 74 |
| CK18.0118 | 9472602230 9472652301 | 1-2 Vites Hilali G131 YENİ MODEL | 1-2 Clutch Fork G131 New Model | 75 |
| CK18.0119 | 9472651202 9472602730 9472602530 | 3-4 Vites Hilali G131 YENİ MODEL | 3-4 Clutch Fork G131 New Model | 75 |
| CK18.0120 | 9472650601 | 1-2 Vites Hilali G131 ESKİ MODEL | 1-2 Clutch Fork G131 Old Model | 75 |
| CK18.0121 | 9472650802 | 3-4 Vites Hilali G131 ESKİ MODEL | 3-4 Clutch Fork G131 Old Model | 76 |
| CK18.0122 | 9452650001 | Buçuk Vites Hilali | Clutch Fork Half | 76 |
| CK18.0123-1 | 9472651901 9472650901 | Ağır Seri Hilali YENİ MODEL | Clutch Fork-Heavy Series New Model | 76 |
| CK18.0123-2 | 9472650801 9472652701 9472651701 | Ağır Seri Hilali ESKİ MODEL | Clutch Fork-Heavy Series Old Model | 76 |
| CK18.0124 | 9452652974 9452652774 9452651274 | Hilal Vidası Kısa Tip | Clutch Fork Screw Short Type | 87 |
| CK18.0125 | 9452652874 9452652574 9452651374 | Hilal Vidası Uzun Tip | Clutch Fork Screw Long Type | 87 |
| CK18.0126 | 9452602630 9452603730 9452601030 | 3-4 VİTES HİLALİ G211 TİRİPTONİK | 3-4 Clutch Fork G211 Tiriptonik | 77 |
| CK18.0127 | 3892650601 | BUÇUK HİLALİ | Clutch Fork Half | 77 |
| CK18.0128 | 9452651202 | 3-4 VİTES HİLALİ G221-9 | 3-4 Clutch Fork G221-9 | 77 |
| CK18.0129 | | 1-2 VİTES HİLALİ G221-9 | 1-2 Clutch Fork G221-9 | 77 |
| CK18.0131 | 9452608333 | Vites Kolu | Shifting Rod | 40 |
| CK18.0131-1 | 3892611733 | MİL TAPASI | SHAFT CAP 83 33 | 43 |
| CK18.0132 | 9452600733 | Vites Kolu | Shifting Rod | 40 |
| CK18.0133 | 3892682229 | Vites Kolu | Shifting Rod | 64 |
| CK18.0133-1 | | G155-180-9 VİTES MİL TAMİR TAKIMI | Shifting Rod REPAIR KIT G155-180-9 | 65 |
| CK18.0134 | 3892680829 | Vites Kolu | Shifting Rod | 48-56 |
| CK18.0134-1 | | G155 G180-16 VİTES MİL TAMİR TAKIMI | Shifting Rod REPAIR KIT G155 G180-16 | 52-58 |
| CK18.0135 | 9452608233 | Vites Kolu | Shifting Rod | 79 |
| CK18.0136 | 3892605682 | Frezeli Kovan | sleeve assy | 49-56 |
| CK18.0137 | 3892683650 | Frezeli Kovan | sleeve assy | 65 |
| CK18.0138 | 3892670238 | Eksantrik | Thrust Piece | 57-64 |
| CK18.0139 | 9452680013 3892680446 | Kumanda Yuvası | Shifting Segment | 42-51-58-67 |

| CEKA NO | OEM | Ürün Tanımı | Product Description | Page |
|-------------|------------|---|--|-------------|
| CK18.0140 | 9452680046 | G240 EKSANTİRİK | Shifting Segment Range Group Valve MPS | 41-50 |
| CK18.0140-0 | 3872680974 | Kumanda Fişeği | Selector Pin | 43-51-58-67 |
| CK18.0140-1 | 3872680974 | Kumanda Fişeği Delikli | Selector Pin With Hole | 88 |
| CK18.0140-2 | 3879932201 | Büyük Yay | Big Spring | 43-51-59-67 |
| CK18.0140-3 | 3879932101 | Küçük Yay | | 43-51-59-67 |
| CK18.0140-4 | | KUMANDA FİŞEĞİ AÇILI | Selector Pin Angle | 89 |
| CK18.0141-1 | 9452680746 | Kumanda Yuvası Kısa Pim | Detent For Short Pin | 41 |
| CK18.0141-2 | 9452680746 | Kumanda Yuvası Uzun Pim | Detent With Long Pin | 52-59-68 |
| CK18.0142 | | TAKVIYE KİLİT FİŞEĞİ | Selector Pin With Hole | 89 |
| CK18.0143 | 9452681025 | Frezeli Kovan | sleeve assy | 39 |
| CK18.0144 | 3892681150 | Burç | Bushing | 49-58 |
| CK18.0144-1 | 0189816110 | HK 25-20 İÇNELİ RULMAN | BEARING HK 25-20 | 53-60 |
| CK18.0145 | 3892650216 | Seçici Mil | Fork With Pin and Snap Ring | 50-57 |
| CK18.0146 | 3892650230 | Seçici Kol | Selector lever module | 50-57 |
| CK18.0147 | 3892680533 | Arama Kolu | Shifting Finger | 57-64 |
| CK18.0148 | 3892682616 | Arama Mandalı | Pawl Actros | 56-63 |
| CK18.0149 | 3892681212 | Kule Gövde | Conversion Kit Cover | 55 |
| CK18.0149-1 | 0099810510 | İÇNELİ RULMAN HK 32-20 BİLYA | Bearing HK 32-20 | 44-53-60-68 |
| CK18.0150 | 3892686412 | Düz Kapak | Bearing Cover | 55 |
| CK18.0150-1 | 0079812110 | HK 38-20 İÇNELİ RULMAN | Bearing HK 38-20 | 44-52-60-68 |
| CK18.0150-2 | | KEÇE | Oil Seal | 60 |
| CK18.0151 | 3892681712 | Kule Ana Gövde | Conversion Kit Front Cover | 55 |
| CK18.0151-1 | 3892611433 | GÖVDE TAPASI | Cover Cap | 44-52-59-68 |
| CK18.0152 | 3892680001 | Arama Kapağı | Lever Assy | 48-55 |
| CK18.0152-1 | 3892680001 | ARAMA KAPAĞI UZUN | Lever Assy Long Model | 48 |
| CK18.0152-2 | 3892680001 | ARAMA KAPAĞI ZİĞZAK | Lever Assy Z Model | 49 |
| CK18.0153 | 3892688334 | Kule Gövde | Conversion Kit Cover | 63 |
| CK18.0154 | 3892683412 | Kule Gövde | Conversion Kit Cover | 63 |
| CK18.0155 | 3892683212 | Kule Gövde | Conversion Kit Cover | 63 |
| CK18.0156 | 3892680715 | Arama Kolu | Shift Lever MPS | 66 |
| CK18.0157 | 3892614518 | KEÇE KAPAĞI OTOBÜS | Transmission Case Cover Bus | 89 |
| CK18.0158 | 9452682929 | KULE MİLİ | Shifting Rod | 80 |
| CK18.0159 | 9472680225 | G131 KİLİTLEME MİLİ | Shifting Rod G131 | 80 |
| CK18.0159-1 | 9452681474 | Kule Mili Fişeği | Pin | 42 |
| CK18.0159-2 | 9459933901 | Kule Mili Fişek Yayı | Pin Spring | 42 |
| CK18.0159-3 | 9452682250 | Kule Mili Fişek Burcu | pin Bushing | 42 |
| CK18.0159-4 | | G240 KULE TAMİR TAKIMI | Pin Assy G240 | 41 |
| CK18.0160 | 3892684825 | KİLİTLEME MİLİ UZUN-16VİTES-G155 G180 | Rod for Control-16Gear-G155 G180 | 81 |
| CK18.0161 | 9452680225 | G240 G211-16 VİTES Kilitleme Mili-Uzun | Rod for Control G240 G211-16 Gear | 81 |
| CK18.0162 | 3892684925 | G155-9 KİLİTLEME MİLİ KISA | Rod for Control G155-9 | 81 |
| CK18.0162-1 | 3892670974 | Ağır Seri Kilitleme Mili | Interlock Pin | 82 |
| CK18.0162-2 | 3899930601 | Ağır Seri Kilitleme Yayı | Interlock Pin Spring | 82 |
| CK18.0162-3 | 3892680674 | Kilitleme Mil Fişeği | Interlock Pin Selector | 83 |
| CK18.0162-4 | 3899930501 | Kule Mil Fişek Yayı | Interlock Pin Spring | 82 |
| CK18.0162-5 | 9452670274 | Ağır Seri Kilitleme Mili | Interlock Pin | 82 |
| CK18.0163 | 3892612020 | Keçe Kapağı | Transmission Case Cover | 90 |
| CK18.0164 | 3892614518 | Keçe Kapağı | Transmission Case Cover | 89 |
| CK18.0165 | 3892613318 | Keçe Kapağı | Transmission Case Cover | 90 |
| CK18.0166 | 9452611118 | Keçe Kapağı | Transmission Case Cover | 90 |
| CK18.0167 | 6552540708 | Debriyaj Çatalı-MERCEDES | Release Fork-MERCEDES | 90 |
| CK18.0168 | 6552540206 | Debriyaj Tamir Takımı-MERCEDES-1PcSpindle | Release Fork Repair Kit-MERCEDES-1Pc Spindle | 91 |
| CK18.0169 | 0029921501 | Debriyaj Tamir Takımı-MERCEDES-2PcBushing | Release Fork Repair Kit-MERCEDES-2Pc Bushing | 91 |
| CK18.0170 | 0002540335 | Debriyaj Tamir Takımı-MERCEDES-1pcBearing | Release Fork Repair Kit-MERCEDES-1pc Bearing | 88 |
| CK18.0171 | 9483530153 | Diferansiyel Ayar Borusu | Differential Adjuster Pipe | 88 |
| CK18.0172 | 3872670650 | Mil Burcu | Shaft Bushing | 84 |
| CK18.0173 | 3892671018 | AĞIR SERİ PİSTONU | Piston-Control Cylinder | 83 |
| CK18.0174 | 3892677317 | AĞIR SERİ PİSTON MİLİ-G131 | Piston-Control Cylinder G131 | 84 |
| CK18.0175 | 3892673517 | AĞIR SERİ PİSTON MİLİ | Piston-Control Cylinder | 84 |
| CK18.0176 | 9302670217 | AĞIR SERİ PİSTON MİLİ | Piston-Control Cylinder | 84 |
| CK18.0177 | 9452672117 | AĞIR SERİ PİSTON MİLİ | Piston-Control Cylinder | 85 |
| CK18.0178 | 9302670117 | BUÇUK MİLİ | Gear Shift Rail | 85 |
| CK18.0179 | 9452670017 | BUÇUK MİLİ | Gear Shift Rail | 85 |
| CK18.0180 | 3892677217 | AĞIR SERİ PİSTON MİLİ | Piston-Control Cylinder | 85 |
| CK18.0181 | 9762670317 | AĞIR SERİ PİSTON MİLİ | Piston-Control Cylinder | 86 |
| CK18.0182 | 9472670117 | AĞIR SERİ PİSTON MİLİ | Piston-Control Cylinder | 86 |
| CK18.0183 | 9452670617 | AĞIR SERİ PİSTON MİLİ | Piston-Control Cylinder | 86 |
| CK18.0184 | 9302672117 | AĞIR SERİ PİSTON MİLİ | Piston-Control Cylinder | 86 |
| CK18.0185 | 9302670618 | AĞIR SERİ PİSTONU | Piston-Control Cylinder | 83 |
| CK18.0186 | 3872670918 | AĞIR SERİ PİSTONU | Piston-Control Cylinder | 83 |
| CK18.0191 | 3892620407 | HEYKEL PERNOSU MERCEDES | PIN Shaft -Mercedes | 91 |
| CK18.0191-1 | 9472600297 | HEYKEL PERNOSU KL | PIN Shaft-KL | 91 |
| CK18.0191-2 | 9472600197 | HEYKEL PERNOSU G131 | PIN Shaft -G131 | 92 |
| CK18.0192 | 9452680516 | KİLİTLEME MEKANİZMASI | Pawl MPS-HPS | 41-49 |
| CK18.0193 | 9452680133 | VİTES PARMAGI | Shifting finger EPS | 40-50 |
| | 9452680233 | | | |
| | 9452680833 | | | |

Product List

Ürün Listesi

| CEKA NO | OEM | Ürün Tanımı | Product Description | Page |
|-------------|--|--|--|-------|
| CK18.0194 | 9452681334 9452684934 9452684334 | KULE ANA GÖVDE | Bearing Cover | 39 |
| CK18.0195 | 3892650974 | HİLAL VİDASI | Clutch Fork Screw | 87 |
| CK18.0196 | 9452682934 9452604713 | YAN KAPAK | Bearing Cover Assy | 39 |
| CK18.0196-1 | | KEÇE | Oil Seal | 44 |
| CK18.0197 | 9452684634 9452682834 9452604713 9452682650 9452682950 | 240 MİL GÖVDESİ 945 268 06 34 DÖKÜM NUMARASI | Bearing Cover Assy G240 | 39 |
| CK18.0198 | 9452680250 9452682950 | 82 33 MİLİN ÜSTÜNDEKİ BİLYA BORUSU | Bushing shift ball lock 82 33 | 40 |
| CK18.0199 | 9452670619 9472600031 9472604330 3892605930 3892605730 | NVM GV PİSTONU | Piston-Shifting Cylinder | 87 |
| CK18.0200 | 3892603930 3892651702 3892604130 3892606630 3892651502 | 5-6 VİTES HİLALİ G210 G230 | 5-6 Clutch Fork G210 G230 | 78 |
| CK18.0201 | 3892603930 3892651702 | 3-4 VİTES HİLALİ-OTOBÜS | 3-4 Clutch Fork-Bus | 78 |
| CK18.0202 | 3892604130 3892606630 3892651502 | 5-6 VİTES HİLALİ-G170-190 | 5-6 Clutch Fork-G170 G190 | 78 |
| CK18.0203 | 9452650301 | HİLAL DELİKSİZ | Clutch Fork Without Hole | 78 |
| CK18.0204 | 9602600432 9602600732 | Kızak Laması | Sled ruler | 75 |
| CK18.0205 | 3892611120 | DİREKSİYON POMPASI KAPAĞI | Rear Cover Output Flange | 92 |
| CK18.0206 | 2106254 | OTOMATİK ŞANZUMAN.FRENLEME TAKIMI YENİ MODEL | AUTOMATIC TRANSMISSION BRAKE KIT NEW MODEL | 93 |
| CK18.0207 | 2106255 | OTOMATİK ŞANZUMAN.FRENLEME TAKIMI ESKİ MODEL | AUTOMATIC TRANSMISSION BRAKE KIT OLD MODEL | 93 |
| CK18.0208 | 9452685034 | G131 Kule Ana Gövde | G131 Conversion Kit Front Cover | 79 |
| CK18.0209 | 9452680357 9452680057 | G240 Kule Saç Kapak | G240 COVER | 45-53 |
| CK18.0210 | 9452680174 | G240 VİTES KİLİTLEME PİMİ | G240 Pin | 45 |
| CK18.0211 | 3892652102 | HİLAL MİLİ | Clutch Fork Shaft | 79 |
| CK18.0212 | 9762680076 | G240 VİTES ATLATMA AYAR PULU | G240 WASHER | 45 |
| CK18.0213 | | CEKA VİTES KİLİTLEME PİMİ | CEKA Model Pin | 53 |
| CK18.0214 | 3892680334 | G155 KULE SAÇ KAPAK | G155 COVER | 60-69 |
| CK18.0215 | 3892670474 9452682074 3892682374 3892682974 | G155 VİTES KİLİTLEME PİMİ | G155 PIN | 60-69 |
| CK18.0216 | 9452682074 3892682374 3892682974 | Kumanda Fişçesi Bilyalı | Clutch Fork Screw | 88 |
| CK18.0220 | 9602604130 | G240 HİLAL TAKIMI-HİLAL KİTİ | Clutch Fork Assy G240 | 73 |
| CK18.0230 | 3892681150 | BURÇ 3031 KULENİN | Shift Lock Bushing | 66 |
| CK18.0231 | 0179819410 | MASURA BİLYA 3031 KULENİN | Needle Bearing 45-38-20mm | 66 |
| CK18.0233 | 0179973647 | KEÇE 3031 KULENİN | Oil Seal 3031 | 66 |
| CK18.0234 | 3892683950 | BURÇ 3031 KULENİN | Thrust Washer 3031 | 65 |
| CK18.0235 | | GÖVDE TAMİR TAKIMI | Conversion Kit Cover REPAIR KIT | 65 |
| CK18.0236 | 9452680929 | Kule Mili | Conversion Kit Shifting Rod | 80 |
| CK18.0240 | | Ventiler Ve Boru Dahil Set V6 | Gear Lever Assy V6 with 2 Valves | 13 |
| CK18.0241 | | Kule Boru Set V6 | Gear Lever Assy V6 | 13 |
| CK18.0242 | 9302609839 | Vites Kolu | Gear Shift Lever LHD | 37 |
| CK18.0242-1 | | Vites Kolu Tamir Takım | Gear Shift Lever LHD REPAIR KIT | 37 |
| CK18.0242-2 | 9302609839 | Vites Kolu | Gear Shift Lever LHD | 37 |
| CK18.0243 | 9452604833 | Teleskop V6 | Shifting Rod Assy V6 | 34 |
| CK18.0244 | | Ventiler Ve Boru Dahil Set V8 | Gear Lever Assy V8 with 2 Valves | 14 |
| CK18.0245 | | Kule Boru Set V8 | Gear Lever Assy V8 | 14 |
| CK18.0246 | 9452604933 | Teleskop V8 | Shifting Rod Assy V8 | 34 |
| CK18.0247 | 9412600063 3852600063 3852600563 | Piston | Shifting Cylinder Gear Rod | 34 |
| CK18.0248 | | Beton Mikseri Vites Sistemi Ve 2 Adet Ventil Dahil | Gear Lever Assy Concrete Mixer With Valves | 15 |
| CK18.0249 | | Beton Mikseri Vites Sistemi | Gear Lever Assy Concrete Mixer Without Valves | 15 |
| CK18.0250 | | CEKA Model Elektrikli V6 Set Boru Ve Zadet Ventil Dahil | Gear Lever Assy-CEKA Electric Model V6 with 2 Valves | 11 |
| CK18.0251 | | CEKA Model Kibritli V6 Set Boru Ve Zadet Ventil Dahil | Gear Lever Assy-CEKA Mechanic Model V6 with 2 Valves | 12 |
| CK18.0252 | | HORTUM | Hydraulic Pipe | 72 |
| CK18.0253 | | RAKOR | FITTING | 72 |
| CK18.0254 | | CEKA Model Elektrikli V6 Set Boru | Gear Lever Assy-CEKA Electric Model V6 without Valves | 11 |
| CK18.0255 | | CEKA Model Kibritli V6 Set Boru | Gear Lever Assy-CEKA Mechanic Model V6 without Valves | 12 |
| CK18.0260 | | G155 Kule Boru Ve Hava Ventil Dahil | Gear Lever Assy G155 with Valve | 16 |
| CK18.0261 | | G155 Kule Ve Boru | Gear Lever Assy G155 without Valve | 16 |
| CK18.0262 | 0002686489 3872680089 | G155 Mafsal | Joint for Shifting Rod G155 | 36 |
| CK18.0262-1 | 6552600439 6522601339 | İSTAVROZ | Joint pinion | 36 |
| CK18.0263 | 6552600439 6522601339 | G155 Vites Kolu | Shift Lever Actuator G155 | 37 |
| CK18.0264 | 3982680025 | Dirsek Lexus V1 CK18.0100-4 | Shifting Rod Lexus V1 CK18.0100-4 | 35 |
| CK18.0265 | 6552600233 | Dirsek Lexus V2 CK18.0100-5 | Shifting Rod Lexus V2 CK18.0100-5 | 35 |
| CK18.0266 | 3892609933 | Dirsek CK18.0100-3 | Shifting Rod CK18.0100-3 | 35 |
| CK18.0267 | 6522606633 | Dirsek CK18.0100-1 | Shifting Rod CK18.0100-1 | 35 |
| CK18.0268 | 3852609433 | Teleskop G155 | Shifting Rod Assy | 34 |
| CK18.0270 | | Actros Otobüs GS Otomatik kule Boru ve Ventil Dahil Elektrikli Model | Actros Bus GS Automatic Gear Lever Assy with Valves Electric Model | 17 |
| CK18.0271 | | Actros Otobüs GS Otomatik kule ve Boru Elektrikli Model | Actros Bus GS Automatic Gear Lever Assy Electric Model | 17 |
| CK18.0272 | | Actros Otobüs GS Otomatik kule Boru ve Ventil Dahil Kibritli Model | Actros Bus GS Automatic Gear Lever Assy with Valves Mechanic Model | 18 |
| CK18.0273 | | Actros Otobüs GS Otomatik kule ve Boru Kibritli Model | Actros Bus GS Automatic Gear Lever Assy Mechanic Model | 18 |
| CK18.0274 | | Actros Otobüs MP1 kule Boru ve Ventil Dahil Elektrikli Model | Actros Bus MP1 Gear Lever Assy with Valves Electric Model | 19 |

| CEKA NO | OEM | Ürün Tanımı | Product Description | Page |
|-------------|--|--|---|------|
| CK18.0275 | | Actros Otobüs MP1 kule ve Boru Elektrikli Model | Actros Bus MP1 Gear Lever Assy Electric Model | 19 |
| CK18.0276 | | Actros Otobüs MP1 kule Boru ve Ventil Dahil Kibritli Model | Actros Bus MP1 Gear Lever Assy with Valves Mechanic Model | 20 |
| CK18.0277 | | Actros Otobüs MP1 kule ve Boru Kibritli Model | Actros Bus MP1 Gear Lever Assy Mechanic Model | 20 |
| CK18.0278 | | Actros Otobüs MP2 MP3 kule Boru ve Ventil Dahil Elektrikli Model | Actros Bus MP2 MP2 Gear Lever Assy with Valves Electric Model | 21 |
| CK18.0279 | | Actros Otobüs MP2 MP3 kule ve Boru Elektrikli Model | Actros Bus MP2 MP2 Gear Lever Assy Electric Model | 21 |
| CK18.0280 | | Actros Otobüs MP2 MP3 kule Boru ve Ventil Dahil Kibritli Model | Actros Bus MP2 MP2 Gear Lever Assy with Valves Mechanic Model | 22 |
| CK18.0281 | | Actros Otobüs MP2 MP3 kule ve Boru Kibritli Model | Actros Bus MP2 MP2 Gear Lever Assy Mechanic Model | 22 |
| CK23.0100 | 1304302316 1304402316 | Keçe Kapağı BMC | Transmission Case Cover BMC | 95 |
| CK23.0101 | 1304402319 1304302319 | Keçe Kapağı FORD | Transmission Case Cover FORD | 95 |
| CK23.0102 | 1304402213 1304302213 | Keçe Kapağı MAN | Transmission Case Cover MAN | 95 |
| CK23.0103 | 1315402072 1315302072 1315202055 | Keçe Kapağı IVECO | Transmission Case Cover IVECO | 95 |
| CK23.0104 | 1315402106 1315302106 1315202058 | Keçe Kapağı RENAULT | Transmission Case Cover RENAULT | 96 |
| CK23.0105 | 1315402134 1315302122 1315302134 1315302061 | Keçe Kapağı MAN | Transmission Case Cover MAN FORD | 96 |
| CK23.0106 | 1315302134 1315402134 | Keçe Kapağı HİNO-Ø61mm | Transmission Case Cover HİNO-Ø61mm | 96 |
| CK23.0107 | 1315402075 1315302075 | Keçe Kapağı DAF | Transmission Case Cover DAF | 96 |
| CK23.0108 | 1315402136 1315302136 | Keçe Kapağı MAN | Transmission Case Cover MAN | 97 |
| CK23.0109 | 1304301119 1304301332 1324301169 1324301119 | 109luk Ön Gövde Otobüs | Front Cover for Bus 109luk | 97 |
| CK23.0110 | 1304301431 1304301331 1304301413 | 109luk Ön Gövde | Front Cover 109luk | 97 |
| CK23.0111 | 1315268017 81324110007 | Debriyaj Çatalı MAN | Release Fork MAN | 98 |
| CK23.0112 | 1315406080 1315306080 | Debriyaj Çatalı Yatağı | Release Fork Housing MAN | 98 |
| CK23.0113 | 81305606022 | Debriyaj Çatalı Tamir Takımı MAN | Release Fork Repair Kit MAN | 98 |
| CK23.0114 | 1315307343 | ZF Kule Mili DAF | Shifting Rod ZF DAF | 99 |
| CK23.0115 | 1304307474 | ZF Kule Mili Fortuna | Shifting Rod ZF Fortuna | 99 |
| CK23.0116 | 1315307264 | ZF Kule Mili MAN | Shifting Rod ZF MAN | 99 |
| CK23.0117 | 1315307327 | ZF Kule Mili IVECO | Shifting Rod ZF IVECO | 99 |
| CK23.0118 | 1315307376 | ZF Kule Mili RENAULT | Shifting Rod ZF RENAULT | 100 |
| CK23.0119 | 1304307267 | ZF Kule Mili FORD | Shifting Rod ZF FORD | 100 |
| CK23.0120 | 1304307262 | ZF Kule Mili MAN | Shifting Rod ZF MAN | 100 |
| CK23.0121 | 1304307266 | ZF Kule Mili-9Delik | Shifting Rod ZF-9Hole | 100 |
| CK23.0122 | 1315332053 | Heykel Perno | Planet Pin Shaft | 104 |
| CK23.0123 | 1316332096 | Heykel Perno | Planet Pin Shaft | 105 |
| CK23.0123-1 | 0750119116 | Heykel Perno Bilyası | Planet Pin Shaft Bearing | 105 |
| CK23.0124 | 1315307094 | ZF Kule Mili MAN | Shifting Rod ZF MAN | 101 |
| CK23.0125 | 1315307249 | ZF Kule Mili DAF | Shifting Rod ZF DAF | 101 |
| CK23.0126 | 1308307062 | ZF Kule Mili Mercedes | Shifting Rod ZF Mercedes | 101 |
| CK23.0127 | 1315307326 | Vites Topu Borusu | Gearshift Shaft | 106 |
| CK23.0128 | 1315307294 | Vites Topu Borusu | Gearshift Shaft | 106 |
| CK23.0129 | 0735470126 | Kule Mili Pimi | Shifting Rod Pin | 107 |
| CK23.0129-1 | | KULE MİLİ PİMİ YARGILI | Conversion Kit Shaft Pin | 108 |
| CK23.0130 | 1304307158 | Ön Kapak FORD | Front Cover FORD | 109 |
| CK23.0131 | 1304307375 | Arka Kapak | Back Cover FORD | 109 |
| CK23.0132 | 1304407425 | 109luk Kule Yan Kapak | Side Cover 109luk | 109 |
| CK23.0133 | 1304307257 | Yay Kapağı | Spring Cover | 109 |
| CK23.0133-1 | 0732040255 | KAPAK YAYI | Cover For Spring | 109 |
| CK23.0134 | 0730260330 | 25lik Kule Mil Burcu | Brass bushing 25 | 102 |
| CK23.0135 | 0730260703 | 28lik Kule Mil Burcu | Brass bushing 28 | 102 |
| CK23.0136 | 1316208003 | Vites Topu Pimi | Selector Pin | 108 |
| CK23.0137 | 0731201732 | Pim | Pin | 108 |
| CK23.0138 | 0635303019 | Rulman | Bearing | 108 |
| CK23.0139 | 1304307442 1304307261 | Vites Topu | Carrier | 103 |
| CK23.0140 | 1315307188 1315307733 | Vites Topu | Carrier | 103 |
| CK23.0141 | 1315307333 1315307735 | Vites Topu | Carrier | 103 |
| CK23.0142 | 1315307319 1315307734 | Vites Topu | Carrier | 103 |
| CK23.0144 | 1304307255 | Geri Vites İstinat Burcu | Reverse Gear Bushing | 104 |
| CK23.0145 | 1315307438 | SERVO KULE MİLİ-RENO | SHIFTING SHAFT Renault | 101 |
| CK23.0146 | 1315307397 | MİL BORUSU RENO | Gearshift Shaft Renault | 107 |
| CK23.0147 | 1316332109 | KAMALI MİL ARKA PUL | PRESSURE DISC | 109 |
| CK23.0148 | 1315332073 | KAMALI MİL ARKA PUL | PRESSURE DISC | 110 |
| CK23.0149 | 0750119125 | 4VİTES MASURA BİLYA ÇANAĞI 151 LİK ŞANZIMAN | INNER RING 151 | 109 |
| CK23.0150 | 0750119124 | 4VİTES MASURA BİLYA ÇANAĞI UZUN 221 ŞANZIMAN | INNER RING 221 | 109 |
| CK23.0151 | 0750101158 | 4VİTES ÇANAK ALIN PULU-81.45-67.20-4.98mm | INNER RING 81.45-67.20-4.98mm | 110 |
| CK23.0152 | 1315304043 | KAMALI MİL UÇ BİLYA PULU-81.7-55-7.5MM | INNER RING 81.7-55-7.5MM | 110 |
| CK23.0153 | 1315304044 | KAMALI MİL UÇ BİLYA PULU-81.7-55-7.6MM | INNER RING 81.7-55-7.6MM | 110 |
| CK23.0154 | 1315304045 | KAMALI MİL UÇ BİLYA PULU-81.7-55-7.7MM | INNER RING 81.7-55-7.7MM | 111 |

Product List

Ürün Listesi

| CEKA NO | OEM | Ürün Tanımı | Product Description | Page |
|-------------|--|--|---|------|
| CK23.0155 | 1315304046 | KAMALI MİL UÇ BİLYA PULU-81.7-55-7.8MM | INNER RING 81.7-55-7.8MM | 111 |
| CK23.0156 | 1315304047 | KAMALI MİL UÇ BİLYA PULU-81.7-55-7.9MM | INNER RING 81.7-55-7.9MM | 111 |
| CK23.0157 | 1315304048 | KAMALI MİL UÇ BİLYA PULU-81.7-55-8MM | INNER RING 81.7-55-8MM | 111 |
| CK23.0158 | 1358332229 1328332014 1328332041 1358332261 | HEYKEL PERNOSU ASTRONİK | PIN Shaft ASTRONİK | 105 |
| CK23.0159 | 1304332111 | HEYKEL PERNOSU | PIN Shaft | 105 |
| CK23.0160 | 0501310059 | TAKVIYE VENTİL-KİBRİT KUTUSU | 4-2way Valve Replaces | 71 |
| CK23.0161 | 1316321016 | PİSTON | Piston ZF | 113 |
| CK23.0162 | 1315307395 1341307055 | VİTES ATLATMA MANDALI | Shifting Finger | 104 |
| CK23.0163 | 1341307054 | VİTES TOPU Y | Shifting Finger | 104 |
| CK23.0164 | 1341307108 | VİTES BORUSU | Gearshift Shaft | 107 |
| CK23.0165 | 1315307435 | VİTES BORUSU | Gearshift Shaft | 107 |
| CK23.0166 | 1316332140 | HEYKEL PERNOSU 221 ŞANZIMAN | PIN Shaft 221 | 106 |
| CK23.0167 | 1315332091 | HEYKEL PERNOSU 151 ŞANZIMAN | PIN Shaft 151 | 106 |
| CK23.0168 | 1315307068 | Keçe Kapağı FORD | Transmission Case Cover Ford | 97 |
| CK23.0170 | 1499298023 | EMN-SAC VE PRİZ-KİL-TAK 4,6MM | Shims Kit 4,6MM | 112 |
| CK23.0171 | 1499298024 | EMN-SAC VE PRİZ-KİL-TAK 4,7 MM | Shims Kit 4,7 MM | 112 |
| CK23.0172 | 1499298025 | EMN-SAC VE PRİZ-KİL-TAK 4,8 MM | Shims Kit 4,8 MM | 112 |
| CK23.0173 | 1499298026 | EMN-SAC VE PRİZ-KİL-TAK 4,9 MM | Shims Kit 4,9 MM | 112 |
| CK23.0174 | 1499298027 | EMN-SAC VE PRİZ-KİL-TAK 5 MM | Shims Kit 5 MM | 113 |
| CK23.0175 | 1295307274 | ZF Kule Mili 130LUK | Conversion Kit Shifting Rod 130LUK | 102 |
| CK23.0176 | 1324307260 | ZF Kule Mili Ford | Conversion Kit Shifting Rod FORD | 102 |
| CK23.0177 | 0731208242 | Astronik Kule Fişek | Astronik Conversion Kit Pin | 113 |
| CK23.0179 | 0501314215 0501314216 4130210011 1024302050 | OTOMATİK ŞANZUMAN.FRENLEME TAKIMI YENİ MODEL | AUTOMATIC TRANSMISSION BRAKE KIT NEW MODEL ZF | 114 |
| CK23.0180 | 4130210011 1024302050 | OTOMATİK ŞANZUMAN.FRENLEME TAKIMI ESKİ MODEL | AUTOMATIC TRANSMISSION BRAKE KIT OLD MODEL ZF | 114 |
| CK23.0190 | | ZF VİTES BORUSU DAR KABİN | Gear Linkage System ZF NARROW CABIN | 32 |
| CK23.0190-1 | 6452600282 | ZF Dirsek Dar Kabin | Shifting Rod ZF CK23.0190 | 36 |
| CK23.0190-2 | 3852606039 3852607439 | ZF Vites Kolu Model kısa | Shift Lever Actuator ZF Short Model | 37 |
| CK23.0191 | | ZF VİTES BORUSU GENİŞ KABİN | Gear Linkage System ZF Wide CABIN | 32 |
| CK23.0191-1 | 6202608547 | ZF Dirsek Geniş Kabin | Shifting Rod ZF CK23.0191 | 36 |
| CK30.0100 | 1490550 1515430 | Keçe Kapağı SCANIA | Transmission Case Cover SCANIA | 116 |
| CK30.0101 | 1479578 1737306 | Debriyaj Çatalı SCANIA | Release Fork SCANIA | 116 |
| CK30.0102 | 602582 | Debriyaj Tamir Takımı SCANIA | Release Fork Repair Kit SCANIA | 116 |
| CK40.0100 | 1521978 20366711 | Prizdirek Keçe Kapağı VOLVO | Transmission Case Cover VOLVO | 115 |
| CK40.0100-1 | 20806212 31919671 | Prizdirek Keçe Kapağı VOLVO TAMİR TAKIMI | Transmission Case Cover VOLVO REPAIR KIT | 115 |
| CK40.0101 | 8171176 8172031 | Debriyaj Çatalı VOLVO | Release Fork VOLVO | 115 |
| CK70.001 | 9408914820 | KABİN KULAĞI-SOL | BEARING BRACKET FRONT LEFT | 117 |
| CK70.002 | 9408914920 | KABİN KULAĞI-SAĞ | BEARING BRACKET FRONT Right | 117 |
| CK80.001 | | Ana Aparat | Main Part For All Puller Kit | 119 |
| CK80.002 | | Dip Rulman Ara Uzatma M85-M70 | M85 x M70 Extention For Deep Bearing | 119 |
| CK80.003 | | Prizdirek Rulman Ara Uzatma M85-M85 | M85 x M85 Extention For Input Shaft | 119 |
| CK80.004 | | M100-M70 Kamalı Mil Arka Rulman Uzatması | M100 x M70 Extention For Main Shaft . | 119 |
| CK80.005 | | M70-M70 Ara Uzatma | M70 x M70 Extention | 120 |
| CK80.101 | | G240 Kamalı Mil Uç Rulman Çektirmesi | G240-210 First Bearings Puller For Main Shaft | 120 |
| CK80.102 | | G210 G211 Kamalı Mil Uç Rulman Çektirmesi | G211 First Bearings Puller For Main Shaft | 120 |
| CK80.103 | | G155 G180 Kamalı Mil Uç Rulman Çektirmesi | G155-180 First Bearings Puller For Main Shaft | 120 |
| CK80.104 | | G100 Kamalı Mil Uç Rulman Çektirmesi | G100 First Bearings Puller For Main Shaft | 121 |
| CK80.105 | | G240 4Vites Dişli Çektirmesi | G240 Gear 4th Puller | 121 |
| CK80.106 | | G210-G211 4-Vites Dişli Çektirmesi | G210-G211-G155-G180 Gear 4th Puller | 121 |
| CK80.107 | | G100 6-Vites Dişli Çektirmesi | G100 Gear 6th Puller | 121 |
| CK80.108 | | G155 G211 G240 4Vites Rulman Ayar Aparatı | G155-211-240 Gear 4th Bearings Adjustment Part | 122 |
| CK80.109 | | G155 G211 G240 Kamalı Mil Tutma Aparatı | G155-211-240 For Holding Main Shaft . | 122 |
| CK80.110 | | G240 4-Vites Dip Rulman Çektirmesi | G240 Deep Bearing Puller For Gear 4th | 122 |
| CK80.111 | | G155 G210 4Vites Dip Rulman Çektirmesi | G155-210 Deep Bearing Puller For Gear 4th | 122 |
| CK80.112 | | G100 6-Vites Dip Rulman Çektirmesi | G100 Deep Bearing Puller For Gear 6th | 123 |
| CK80.113 | | G155 G211 G240 Grup Mili Arka Rulman Çektirmesi | G155-211-240 Rear Bearing Puller for Counter Shaft | 123 |
| CK80.114 | | G155 G211 G240 Grup Mili Ön Rulman Çektirmesi | G155-211-240 Front Bearing Puller for Counter Shaft | 123 |
| CK80.115 | | G155 G211 G240 Kamalı Mil Arka Rulman Çektirmesi | G155-211-240 Rear Bearing For Main Shaft | 123 |
| CK80.116 | | G155 G211 G240 Prizdirek Büyük Rulman Çektirmesi | G155-211-240 Big Bearing Fot Input Shaft | 124 |
| CK80.117 | | G131 Kamalı Mil Uç Rulman Çektirmesi | G131 First Bearings Puller For Main Shaft | 124 |
| CK80.118 | | Otobüs Kamalı Mil Uç Rulman | Bus / First Bearings Puller for Main Shaft | 124 |
| CK80.119 | | G221 Kamalı Mil Uç Bilya Çek. | G221 First Bearings Puller For Main Shaft | 124 |
| CK80.120 | | G100 Prizdirek Büyük Rul Çek | G100 Big Bearing Fot Input Shaft . | 125 |
| CK80.121 | | KL 211 Kamalı Arka Rul Çek | KL 211 Rear Bearing For Main Shaft | 125 |
| CK80.122 | | KL 211-3Vites Dip Rulman | KL 211- Deep Bearing Puller For Gear 3rd | 125 |
| CK80.123 | | KL 211 Grup Mili Arka Rulman | KL 211 Rear Bearing Puller for Counter Shaft | 125 |
| CK80.124 | | KL 211 Grup Mili Ön Rulman | KL 211 Front Bearing Puller for Counter Shaft | 126 |
| CK80.125 | | KL 330-281-240-211- Kamalı Mil Arka Rulman | KL 330-281-240-211- Rear Bearing For Main Shaft | 126 |
| CK80.126 | | Mer155-180-210-210-211-240-Roterdarlı Arka Aktarma Çektirmes | 155-180-210-211-240-RETARDER | 126 |
| CK80.127 | | KL 281-330-3 CÜ VİTES DİŞLİ ÇEKTİRME | KL 281-330-3Head Shaft Gear Puller | 126 |
| CK80.128 | | KL 281-330-3 CÜ VİTES DİPRULMAN ÇEKTİRMESİ | KL 281-330-3Head Bearing Gear Puller | 127 |
| CK80.129 | | KL 281-330 GRUP ARKA RULMAN ÇEKTİRMESİ | KL 281-330 Rear Bearing Puller for Counter Shaft | 127 |

| CEKA NO | OEM | Ürün Tanımı | Product Description | Page |
|----------|-----|---|---|------|
| CK80.201 | | ZF 151-181-221 Kamalı Mil Uç Rulman Çektirmesi | ZF 151-181-221 First Bearings Puller For Main Shaft | 127 |
| CK80.202 | | ZF 9 S 109-16 S 109 Kamalı Mil Uç Rulman Çektirmesi | ZF 9 S 109- 16 S 109 First Bearings Puller For Main Shaft | 127 |
| CK80.203 | | ZF 151-221 Prizdirek Büyük Rulman Çektirmesi | ZF 151-221 Big Bearing For Input Shaft | 128 |
| CK80.204 | | ZF 151 Kamalı Mil Arka Rulman Çektirmesi | ZF 151 Rear Bearing For Main Shaft | 128 |
| CK80.205 | | ZF 181-221 Kamalı Mil Arka Rulman Çektirmesi | ZF 181 - 221 Rear Bearing For Main Shaft | 128 |
| CK80.206 | | ZF 151-181-221 Yeni Model Gurup Mili Ön ve Arka Rulman Çektirmesi | ZF 151-181-221 New Model For Counter Shaft Front and Rear Bearing | 128 |
| CK80.207 | | ZF 109 Grup Ön Rulman Çektirmesi | ZF 109 Front Bearing Puller For Counter Shaft | 129 |
| CK80.208 | | ZF 75lik Grup Ön Rulman Çektirmesi | ZF 75 Front Bearing Puller For Counter Shaft | 129 |
| CK80.209 | | ZF 75lik Kamalı Mil Uç Rulman Çektirme | ZF 75 First Bearings Puller For Main Shaft | 129 |
| CK80.210 | | ZF 75 Grup Arka Rul. Çektirmesi | ZF 75 Rear Bearing Puller For Counter Shaft | 129 |
| CK80.211 | | 45 ZF 151-181-211 Grup Mil Ön Arka Rul İç Çanak Çektirmesi 1-1 Çerek e Olur | ZF 151-181-211 Rear Bearing Puller For Counter Shaft | 130 |
| CK80.212 | | ZF 151-181-221 Şaft Filanş Çektirmesi | ZF 151-181-221 Shaft Filanc Puller | 130 |
| CK80.213 | | ZF 151-181-221 Heykel Çektirmesi-Roterdarlıya Da Olur | ZF 151-181-221 Planet Gear Carrier"Differential" Puller | 130 |
| CK80.214 | | ZF Astronik Grup Ön Ve Arka Rul Çek | ZF Astronik Counter Shaft Front and Back Bearing | 130 |
| CK80.220 | | ZF Şanzuman Toplama Aparatı | ZF Gearbox / Collecting Part | 131 |
| CK80.301 | | SCANIA Kamalı Mil Uç Rulman Çektirmesi | SCANIA First Bearings Puller For Main Shaft | 131 |
| CK80.302 | | SCANIA 3-Vites Dişli Çektirmesi | SCANIA Gear 3rd Puller | 131 |
| CK80.303 | | SCANIA 3- Vites Dip Rulman Çektirmesi | SCANIA Deep Bearing Puller For Gear 3rd | 131 |
| CK80.304 | | SCANIA K-Mil Uç Rulman | SCANIA First Bearings Puller For Main Shaft | 132 |
| CK80.305 | | SCANIA K-Mil Uç Rulman GR-905 | SCANIA First Bearings Puller For Main Shaft GR/905 | 132 |
| CK80.306 | | SCANIA RETARDER Büy Rul Çek-GRS900 | SCANIA "RETARDER" Big Bearings Puller .GRS900 | 132 |
| CK80.307 | | SCANIA Gurup Ön-Rulman Çektirmesi | SCANIA First Bearings Puller For Counter Shaft | 132 |
| CK80.308 | | SCANIA Gurup Arka Rulman Çektirmesi | SCANIA 211 Rear Bearing Puller For Counter Shaft | 133 |
| CK80.401 | | VOLVO Kamalı Mil Uç Rulman Çektirmesi | VOLVO First Bearings Puller For Main Shaft | 133 |
| CK80.402 | | VOLVO AT-Şanzuman Seri Senkromeç Çektirme | VOLVO AT.GearBox | 133 |
| CK80.403 | | VOLVO 3-Vites Dişli Çektirmesi | VOLVO Gear 3rd Puller | 133 |
| CK80.404 | | VOLVO 3-Vites Dip Rulman Çektirmesi | VOLVO Deep Bearing Puller For Gear 3rd | 134 |
| CK80.405 | | VOLVO K.Mil Uç Rulman | VOLVO First Bearings Puller For Main Shaft | 134 |
| CK80.406 | | VOLVO Gurup Ön Ve Arka.Rulman Çektirmesi | VOLVO Rear , Front Bearing Puller For Counter Shaft | 134 |
| CK80.407 | | VOLVO Gurup Ön Rulman İnceyip Çektirmesi | VOLVO Front Bearing Puller For Counter Shaft | 134 |
| CK80.408 | | VOLVO Kamalı Mil Arka Güneş Dişli Ve Sekman Pistonu Çek. | VOLVO Rear Gear Puller For Main Shaft | 135 |
| CK80.409 | | VOLVO Kamalı Mil Rulman Ve Prizdirek Ön Rulman Çek. | VOLVO Front Bearing Puller For Main Shaft . | 135 |
| CK80.410 | | AT-ATO-2412-2612-2812-3112-3512 Kamalı Mil Ve Prizdirek Rul Çek. | AT-ATO-2412-2612-2812-3112-3512 Main Shaft and Input Shaft Bearing Puller | 135 |
| CK80.411 | | VT-2412-B Kamalı Mil Ve Prizdirek Rul Çek-İnce Tip Bilya | VT-2412-B Main Shaft and Input Shaft Bearing Puller-Thin Type Bearing | 135 |
| CK80.500 | | DİF MAĞ DİP RUL ÇEK ARA UZATMA | Differential Deep Bearing Puller / Extention | 136 |
| CK80.501 | | TGA-AXSOR-TREVEGO DİF MAĞ DİP RULMAN ÇEK | Differential Deep Bearing Puller . TGA-AXOR-TREVEGO | 136 |
| CK80.502 | | SCANI-MAN 464-463-423-422 DİF MAR DİP RUL ÇEK | Differential Deep Bearing Puller SCANI-MAN 464-463-423-422 | 136 |
| CK80.503 | | AXOR İSTAVROZ YAN AYAR BİL ÇEK BİLYA NO-32020 | Universal Joints Side Adjustment Bearing Puller AXOR NO:32020 | 136 |
| CK80.504 | | İSTAVROZ YAN AYAR BİL ÇEK.422-423-463-464 | Universal Joints Side Adjustment Bearing Puller 422/423/463/464 | 137 |
| CK80.505 | | TGA TGY TGS AXOR RENAULT YAN AYAR BİL ÇEK | Side Adjustment Bearing Puller TGA TGY TGS AXOR RENAULT | 137 |
| CK80.506 | | SCANIA Diferansiyel Yan Büy Rul Çek Tekçeker R780-782 | SCANIA Diferansiyel R780/782 | 137 |
| CK80.507 | | SCANIA Diferansiyel Yan Küç Rul Çek Tekçeker R780-782 | SCANIA Diferansiyel R780/782 | 137 |
| CK80.600 | | RENO 6 TEKER MASKOT ARKA PORYA LOKMASI TIRNAKLI | Renault 6 | 138 |
| CK80.601 | | RENO 10 TEKER DİPRANSİYEL PORYA LOKMASI TIRNAKLI | Renault 10 | 138 |
| CK80.602 | | RENO 10 TEKER DİPRANSİYEL PORYA LOKMASI 77 MM | Renault 10 (77 MM) | 138 |
| CK80.603 | | RENO-VOLVO ÖN PORYA SOMUN LOKMASI 75 MM | Renault-VOLVO (75 MM) | 138 |
| CK80.604 | | NO-VOLVO ÖN PORYA SOMUN LOKMASI 80 MM | Renault-VOLVO (80 MM) | 139 |
| CK80.605 | | RENO-VOLVO ÖN PORYA SOMUN LOKMASI 86 MM | Renault-VOLVO (86 MM) | 139 |
| CK80.606 | | RENO-VOLVO ARKA PORYA SOMUN LOKMASI 101 MM | Renault-VOLVO (101 MM) | 139 |
| CK80.607 | | RENO-VOLVO ARKA PORYA SOMUN LOKMASI 105 MM | Renault-VOLVO (105 MM) | 139 |
| CK80.608 | | RENO-VOLVO ARKA PORYA SOMUN LOKMASI 110 MM | Renault-VOLVO (110 MM) | 140 |
| CK80.609 | | RENO-VOLVO ÖN PORYA SOMUN KAPAK LOKMASI 115 MM | Renault-VOLVO (115 MM) | 140 |
| CK80.610 | | MAN TGA ARKA PORYA SOMUN LOKMASI TIRNAKLI | MAN TGA | 140 |
| CK80.611 | | MERSEDES AKSOR AKTROS ARKA PORYA SOMUN LOKMASI TIRNAKLI | Mercedes Actros Axor | 140 |
| CK80.612 | | MAN 422-463-464 ARKA PORYA SOMUN LOKMASI TIRNAKLI | MAN 422-463-464 | 141 |



+90 332 342 36 05 / Türkçe
+90 537 840 24 82 / Arabic & English



Fevzi Çakmak Mahallesi Elit Sanayi Sitesi 10758.
Sokak No: 1/P, 42050 Karatay/Konya/Turkey

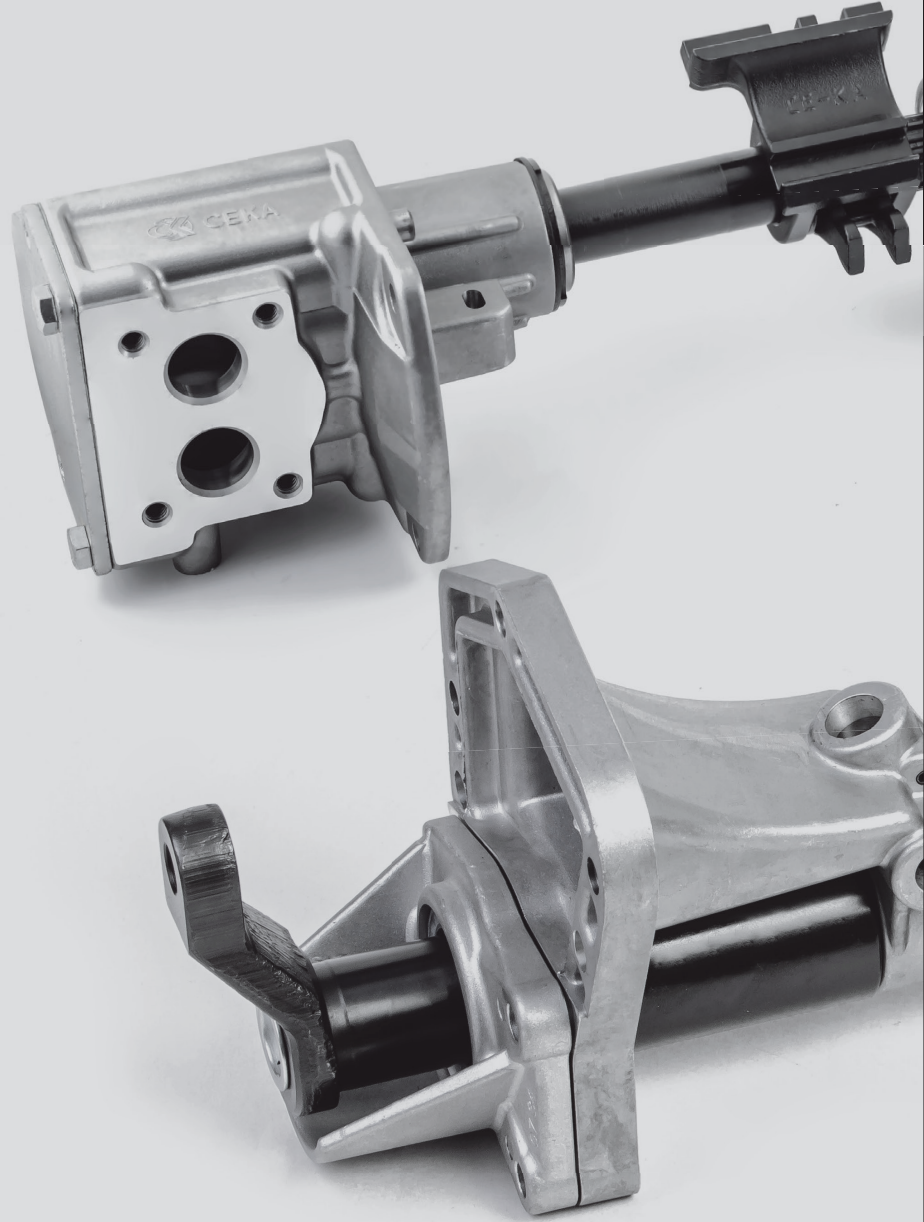

/CeKaAutomotive